



GSM/GPRS/GPS Tracker **GV55**
User Manual

TRACGV55UM001

Revision: 1.03

Document Title	GV55 User Manual
Version	1.03
Date	2013-11-22
Status	Release
Document Control ID	TRACGV55UM001

General Notes

Queclink offers this information as a service to its customers, to support application and engineering efforts that use the products designed by Queclink. The information provided is based upon requirements specifically provided to Queclink by the customers. Queclink has not undertaken any independent search for additional relevant information, including any information that may be in the customer's possession. Furthermore, system validation of this product designed by Queclink within a larger electronic system remains the responsibility of the customer or the customer's system integrator. All specifications supplied herein are subject to change.

Copyright

This document contains proprietary technical information which is the property of Queclink Limited., copying of this document and giving it to others and the using or communication of the contents thereof, are forbidden without express authority. Offenders are liable to the payment of damages. All rights reserved in the event of grant of a patent or the registration of a utility model or design. All specification supplied herein are subject to change without notice at any time.

Copyright © Queclink Wireless Solutions Co., Ltd. 2012

Contents

1 Introduction	7
1.1. Reference	7
1.2. Terms and Abbreviations	7
2 Product Overview	8
2.1. Check Part List	8
2.2. Parts List	9
2.3. Interface Definition	9
2.4. GV55 User Cable Colour	10
3 Getting Started	11
3.1. Opening the Case	11
3.2. Closing the Case	11
3.3. Installing a SIM Card	12
3.4. Installing the Internal Backup Battery	13
3.5. Switch ON the Backup Battery	13
3.6. Power Connection	14
3.7. Ignition Detection	14
3.8. Digital Inputs	15
3.9. Digital Outputs	16
3.10. Device Status LED	18

Table Index

Table 1. GV55 Protocol Reference	7
Table 2. Terms and Abbreviations.....	7
Table 3. Part List	9
Table 4. Description of 6 PIN Connections	10
Table 5. GV55 User Cable Colour definition.....	10
Table 6. Electrical Characteristics of Ignition Detection.....	14
Table 7. Electrical Characteristics of the digital inputs	15
Table 8. Electrical Characteristics of Ddigital Outputs.....	17
Table 9. Definition of Device status and LED	19

Figure Index

FIGURE 1.	APPEARANCE OF GV55	8
FIGURE 2.	THE 6 PIN CONNECTOR ON THE GV55.....	9
FIGURE 3.	OPENING THE CASE.....	11
FIGURE 4.	CLOSING THE CASE.....	11
FIGURE 5.	SIM CARD INSTALLATION.....	12
FIGURE 6.	BACKUP BATTERY INSTALLATION	13
FIGURE 7.	SWITCH AND ON/OFF POSITION	13
FIGURE 8.	TYPICAL POWER CONNECTION.....	14
FIGURE 9.	TYPICAL IGNITION DETECTION	15
FIGURE 10.	TYPICAL DIGITAL INPUT CONNECTION	16
FIGURE 11.	DIGITAL OUTPUT INTERNAL DRIVE CIRCUIT	17
FIGURE 12.	TYPICAL CONNECTION WITH RELAY	17
FIGURE 13.	TYPICAL CONNECTION WITH LED	18
FIGURE 14.	GV55 LED ON THE CASE.....	18

Revision History

Revision	Date	Author	Description of change
1.01	2012-7-3	Owen Feng	Initial
1.02	2012-11-16	Owen Feng	1-change the internal circuit
1.03	2013-11-22	Owen Feng	Change working voltage range

1 Introduction

The GV55 is a powerful GPS locator designed for vehicle or asset tracking. It has superior receiver sensitivity, fast TTFF (Time to First Fix) and supports Dual-Band GSM frequencies 850/900/1800/1900, its location can be monitored in real time or be periodically tracked by a backend server or other specified terminals. The GV55 has multiple input/output interfaces that can be used for monitoring or controlling external devices. Based on the integrated @Track protocol, the GV55 can communicate with a backend server through the GPRS/GSM network to transfer reports of Emergency, geo-fence boundary crossings, low backup battery or scheduled GPS position as well as many other useful functions. Users can also use GV55 to monitor the status of a vehicle and control the vehicle by its external relay output. System Integrators can easily setup their tracking systems based on the full-featured @Track protocol.

1.1. Reference

Table 1. GV55 Protocol Reference

SN	Document name	Remark
[1]	GV55 @Track Air Interface Protocol	The air protocol interface between GV55 and backend server.

1.2. Terms and Abbreviations

Table 2. Terms and Abbreviations

Abbreviation	Description
AGND	Analog Ground
AIN	Analog Input
DIN	Digital Input
DOUT	Digital Output
GND	Ground
MIC	Microphone
RXD	Receive Data
TXD	Transmit Data
SPKN	Speaker Negative
SPKP	Speaker Positive

2 Product Overview

2.1. Check Part List



Before starting, check all the following items have been included with your GV55. If anything is missing, please contact your supplier.



Figure 1. Appearance of GV55

2.2. Parts List

Table 3. Part List

Name	Picture
GV55 Locator	63mm*50mm*21.8mm
User Cable	
DATA_CABLE_M (Optional)	

2.3. Interface Definition

The GV55 has a 6 PIN interface connector. It contains the connections for power, I/O. The sequence and definition of the 6PIN connector are shown in following figure:

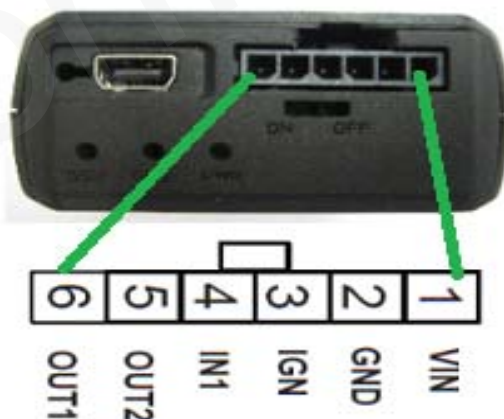

Figure 2. The 6 PIN connector on the GV55

Table 4. Description of 6 PIN Connections

Index	Description	Comment
1	VIN	External DC power input, 8-16V
2	GND	GND
3	IGN	Ignition input, positive trigger
4	IN1	Digital input, negative trigger
5	OUT2	Open drain, 150mA max
6	OUT1	Open drain, 150mA max ,with latch circuit

2.4. GV55 User Cable Colour

Table 5. GV55 User Cable Colour definition

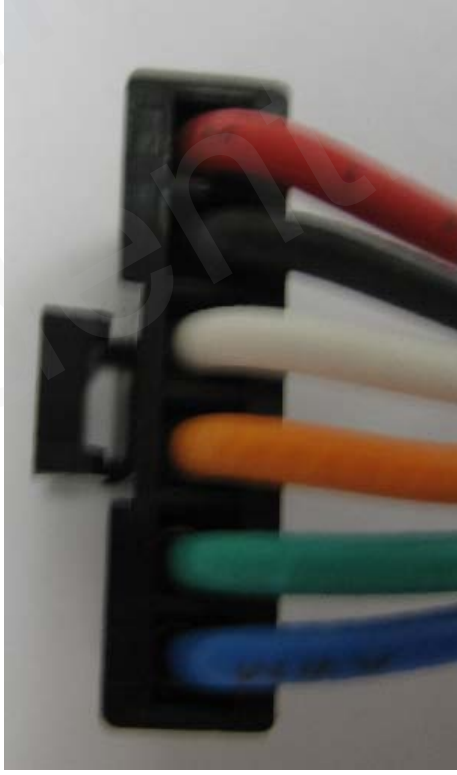
Definition	Color	PIN No	Cable
VIN	Red	1	
GND	Black	2	
IGN	White	3	
IN1	Orange	4	
OUT2	Green	5	
OUT1	Blue	6	

3 .Getting Started

3.1. Opening the Case



Figure 3. Opening the Case

Insert the triangular-pry-opener into the gap of the case as shown below, push the opener up until the case unsnapped.

3.2. Closing the Case



Figure 4. Closing the Case

Place the cover on the bottom in the position as shown in the following figure. Slide the cover against the direction of the arrow until it snapped.

3.3. Installing a SIM Card

Open the case and ensure the unit is not powered (unplug the 6Pin cable and switch the internal battery to off position). Slide the holder right to open the SIM card. Insert the SIM card into the holder as shown below with the gold-colored contact area facing down taking care to align the cut mark. Close the SIM card holder. Close the case.



Figure 5. SIM Card Installation

3.4. Installing the Internal Backup Battery



Figure 6. Backup Battery Installation

There is an internal backup Li-ion battery,

3.5. Switch ON the Backup Battery

To use the GV55 backup battery, the switch must be at the ON position. Switch on the case and ON/OFF position are shown below.



Figure 7. Switch and ON/OFF position

Note:

1-The switch must be on the "OFF" position when shipped on an aircraft.

- 2-When the switch is on the “OFF” position; the battery cannot be charged or discharged.
- 3-To reset the device: Remove the external DC power and second switch off the backup battery. And then supply the external power and switch on the backup battery.

3.6. Power Connection

PWR (PIN1) / GND (PIN2) are the power input pins. The input voltage range for this device is from 8V to 16V. The device is designed to be installed in vehicles that operate on 12V or 24V systems without the need for external transformers.



Figure 8. Typical Power Connection

3.7. Ignition Detection

Table 6. Electrical Characteristics of Ignition Detection

Logical State	Electrical State
Active	5.0V to 32V
Inactive	0V to 3V or Open



Figure 9. Typical Ignition Detection

IGN (Pin3) is used for ignition detection. It is strongly recommended to connect this pin to ignition key “RUN” position as shown up.

An alternative to connecting to the ignition switch is to find a non permanent power source that is only available when the vehicle is running. For example the power source for the FM radio.

IGN signal can be configured to start transmitting information to backend server when ignition is on; and enter power saving mode when ignition is off.

3.8. Digital Inputs

There are one general purpose digital inputs on GV55. They are all negative trigger.

Table 7. Electrical Characteristics of the digital inputs

Logical State	Electrical Characteristics
Active	0V to 0.8V
Inactive	Open

The following diagram shows the recommended connection of a digital input.



Figure 10. Typical Digital Input Connection

3.9. Digital Outputs

There are two digital outputs on GV55. All are of open drain type and the maximum drain current is 150mA. Each output has the built-in over current and recovery PTC fuse

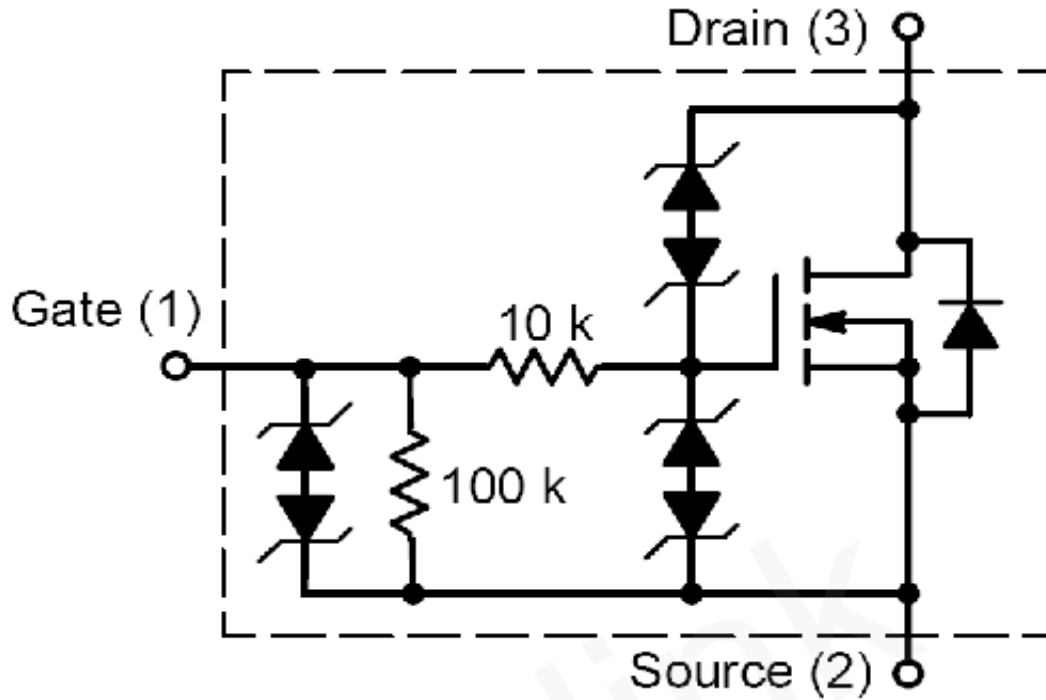

Figure 11. Digital Output Internal Drive Circuit

Table 8. Electrical Characteristics of Ddigital Outputs

Logical State	Electrical Characteristics
Enable	<1.5V @150mA
Disable	Open drain

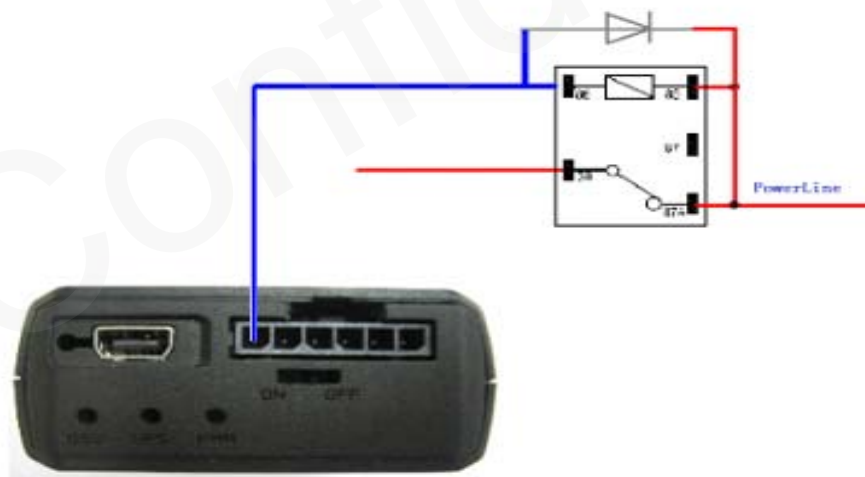

Figure 12. Typical Connection with Relay

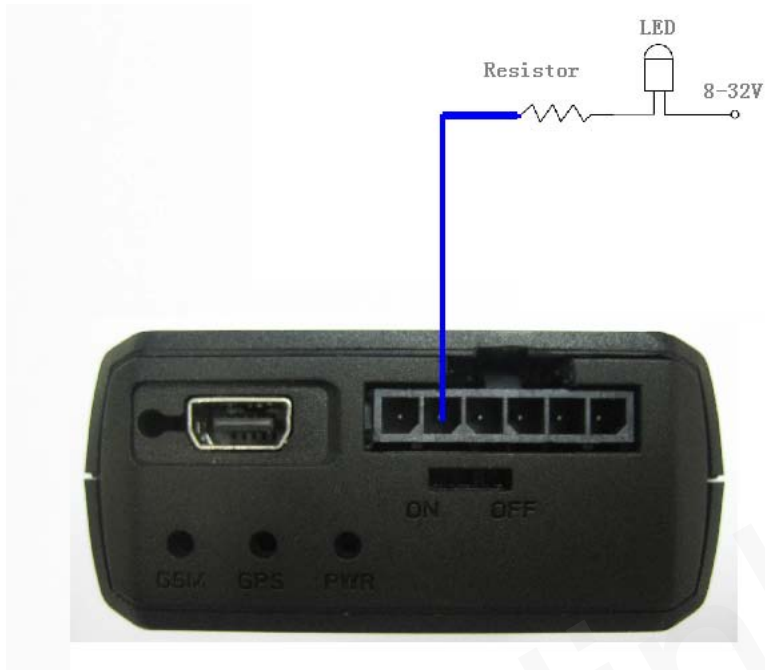

Figure 13. Typical Connection with LED

Note:

- 1 - OUT1 will latch the output state during reset.
- 2- All outputs are internally without pulled up to PWR pin by a diode. So an external flyback diode is needed when the output is connected to an inductive load.

3.10. Device Status LED

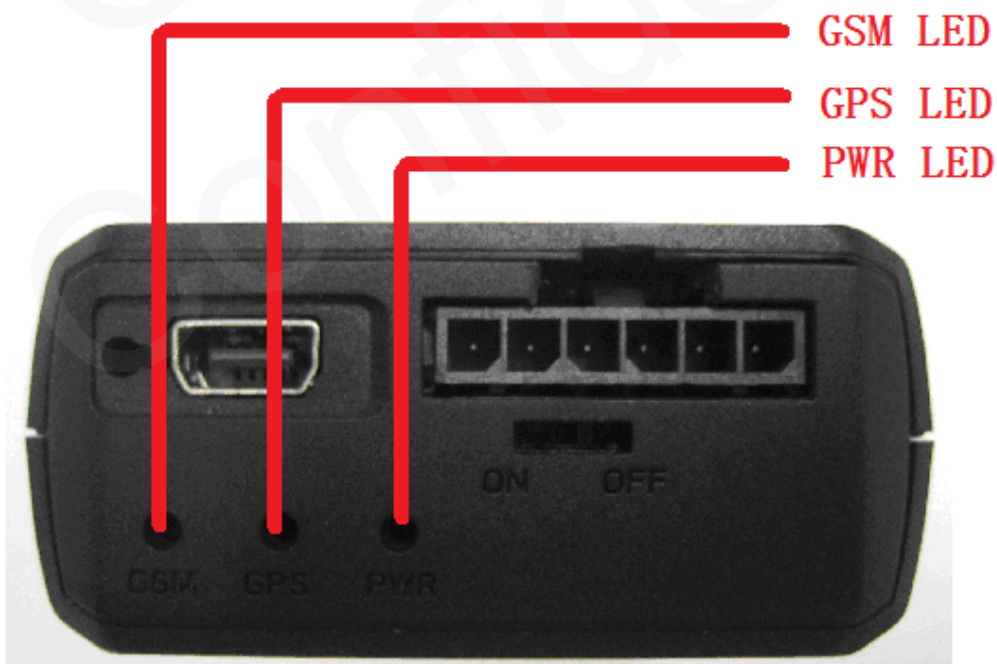

Figure 14. GV55 LED on the Case

GV55 has three status led that GSM GPS PWR led.

Table 9. Definition of Device status and LED

LED	Device status	LED status
GSM (note1)	Device is searching GSM network	Fast flashing (Note3)
	Device has registered to GSM network.	Slow flashing (Note4)
	SIM card needs pin code to unlock.	ON
GPS (note 2)	GPS chip is powered off	OFF
	GPS sends no data or data format error.	Slow flashing
	GPS chip is searching GPS info.	Fast flashing
	GPS chip has gotten GPS info.	ON
PWR (note 2)	No external power and internal battery voltage is lower than 3.35V.	OFF
	No external power and internal battery voltage is below 3.5V.	Slow flashing
	External power in and internal battery is charging	Fast flashing
	External power in and internal battery is fully charged	ON

Note:

- 1 - GSM LED cannot be configured.
- 2 - GPS LED and PWR LED can be configured to turn off after a period of time using the configuration tool
- 3 - Fast flashing is about 60ms ON/ 780ms OFF
- 4 - Slow flashing is about 60ms ON/ 1940ms OFF