



GSM/GPRS/GPS Tracker **GL300**  
**User Manual**

TRACGL300UM001

Revision: 1.01



<http://www.queclink.com>  
[sales@queclink.com](mailto:sales@queclink.com)

<b>Document Title</b>	GL300 User Manual
<b>Version</b>	1.01
<b>Date</b>	2014-05-09
<b>Status</b>	Release
<b>Document Control ID</b>	TRACGL300UM001

### **General Notes**

QuecLink offers this information as a service to its customers, to support application and engineering efforts that use the products designed by QuecLink. The information provided is based upon requirements specifically provided to QuecLink by the customers. QuecLink has not undertaken any independent search for additional relevant information, including any information that may be in the customer's possession. Furthermore, system validation of this product designed by QuecLink within a larger electronic system remains the responsibility of the customer or the customer's system integrator. All specifications supplied herein are subject to change.

### **Copyright**

This document contains proprietary technical information which is the property of QuecLink. Copying of this document and giving it to others and the using or communication of the contents thereof, are forbidden without express authority. Offenders are liable to the payment of damages. All rights reserved in the event of grant of a patent or the registration of a utility model or design. All specification supplied herein are subject to change without notice at any time.

*Copyright © QuecLink Wireless Solutions Co., Ltd. 2014*

## Contents

Contents .....	2
0. Revision history .....	3
1. Introduction.....	4
2. Product Overview .....	5
2.1. Appearance.....	5
2.2. Button/Mini USB Interface Description.....	5
2.3. LED Description .....	6
2.4. External Power Interface.....	6
2.4.1. External DC Charger Interface.....	6
2.4.2. External Battery Interface .....	7
2.5. Ignition Detection.....	7
2.6. External Input Interface.....	8
3. Get Started .....	9
3.1. Parts List.....	9
3.2. Battery Charging .....	10
3.3. GL300 External Cable Interface.....	10
3.4. Install SIM Card.....	11
3.5. Turn on/Turn off.....	11
4. Troubleshooting and Safety Info .....	13
4.1. Troubleshooting.....	13
4.2. Safety Info .....	14

## 0. Revision history

Revision	Date	Author	Description of change
1.00	2013-04-18	Tony Pei	Initial
1.01	2014-05-09	Pam Pan	Proofread writing

## 1. Introduction

GL300 is a powerful GPS tracker designed for asset, vehicle, and pet tracking. With superior receive sensitivity, fast TTF (Time to First Fix) and Quad band GSM frequencies 850/900/1800/1900, its location can be monitored in real time or periodically tracked by a backend server or other devices. Based on the embedded @Track protocol, the GL300 can communicate with the backend server through the GPRS/GSM network (or SMS) to report emergency alerts, geo-fence boundary crossings, low battery and scheduled GPS positions along with several other advanced reporting features. System integrators can easily set up their custom tracking platforms to communicate with the GL300 based on the @Track protocol.

## 2. Product Overview

### 2.1. Appearance



### 2.2. Button/Mini USB Interface Description

Button/mini USB interface description	
Power Key	<ul style="list-style-type: none"> <li>● Turn on GL300</li> <li>● Turn off GL300 when it is not charging. (If power key is enabled)</li> </ul>
Function Key	<ul style="list-style-type: none"> <li>● Geo-fence mode Long press the key to enable/disable geo-fence ID0</li> <li>● Geo-fence in current position mode Long press the key to enable/disable geo-fence ID0. If geo-fence ID0 is enabled, use the current position as the centre of geo-fence 0.</li> <li>● SOS mode (default) Long press the key to activate SOS alarm</li> </ul>
Mini USB Interface	<ul style="list-style-type: none"> <li>● When connected to the interface, a 5V DC adapter can power GL300 and charge the internal battery</li> <li>● When connected to the interface, a 3.7V Li-ion or Li-Polymer battery can power</li> </ul>

	GL300 <ul style="list-style-type: none"> <li>Backend server developer or administrator can use the Data_Cable_M to configure GL300</li> </ul>
--	---

### 2.3. LED Description

There are three LED on GL300, the description as follows.

LED	Event	State
GSM LED	Searching network	Fast flash
	Network has been registered	Slow flash
	Power off	Dark
	SIM-PIN locked	Solid
	Receive a valid protocol command	Turn on and keep on for 3 seconds
	<LED on> is 2	Dark
GPS LED	GPS has fixed	Solid
	GPS is in fixing	Fast flash
	GPS is on and GPS data is wrong	Slow flash
	GPS is off	Dark
	If <LED on> is 0, and 150 seconds has passed after power on.	Dark
	<LED on> is 2	Dark
Power LED	Power on and normal	Dark
	Charger inserted and charging completed	Solid
	Charger inserted and charging	Fast flash
	Prepare to power off after power key is pressed	Fast flash
	Abnormal	Fast flash
	Power low alert	Slow flash
	Power off or turn off the power light by command	Dark
	<LED on> is 2	Dark

### 2.4. External Power Interface

#### 2.4.1. External DC Charger Interface

The Pin 2 on mini-USB connector is used for charging and named VCHG pin. It can be connected to a 5V DC power supply to power GL300 and charge the internal battery.

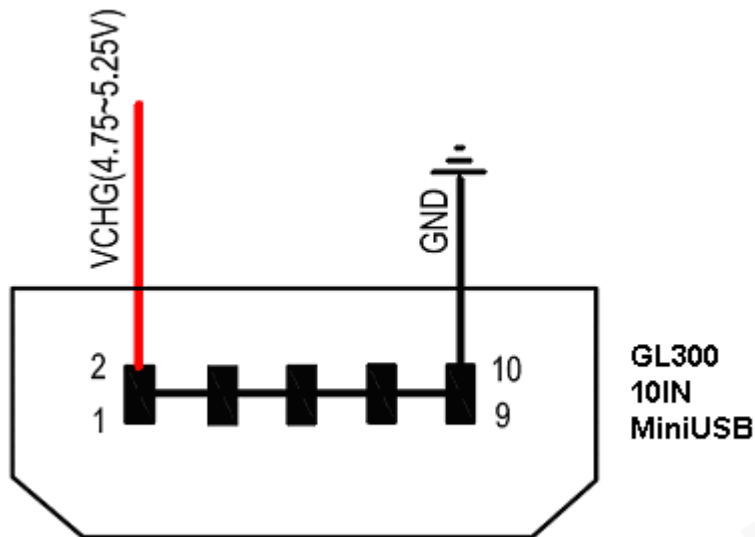

### 2.4.2. External Battery Interface

The Pin 8 on mini-USB connector is for external battery and named EXTBAT pin. It can be connected to 3.7V Li-ion or Li-Polymer battery to power GL300.

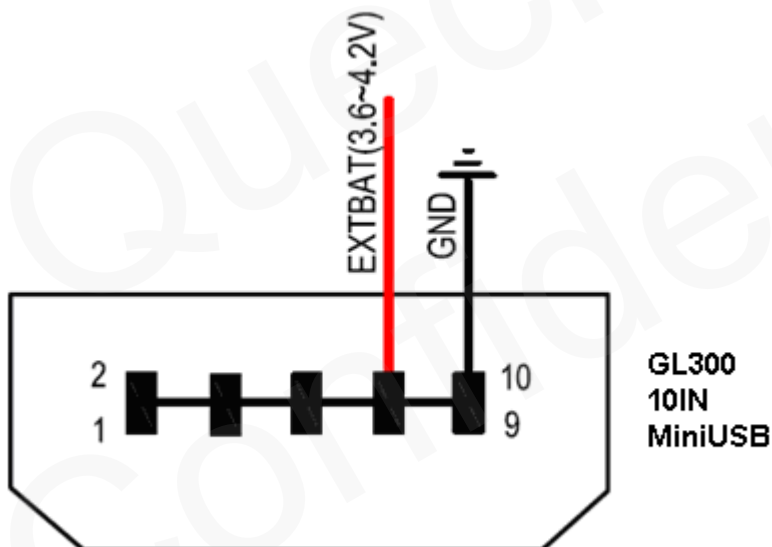

### 2.5. Ignition Detection

The Pin 7 on mini-USB connector is for ignition detection when GL300 is used in vehicle tracking application. It is named IGN\_IND pin.



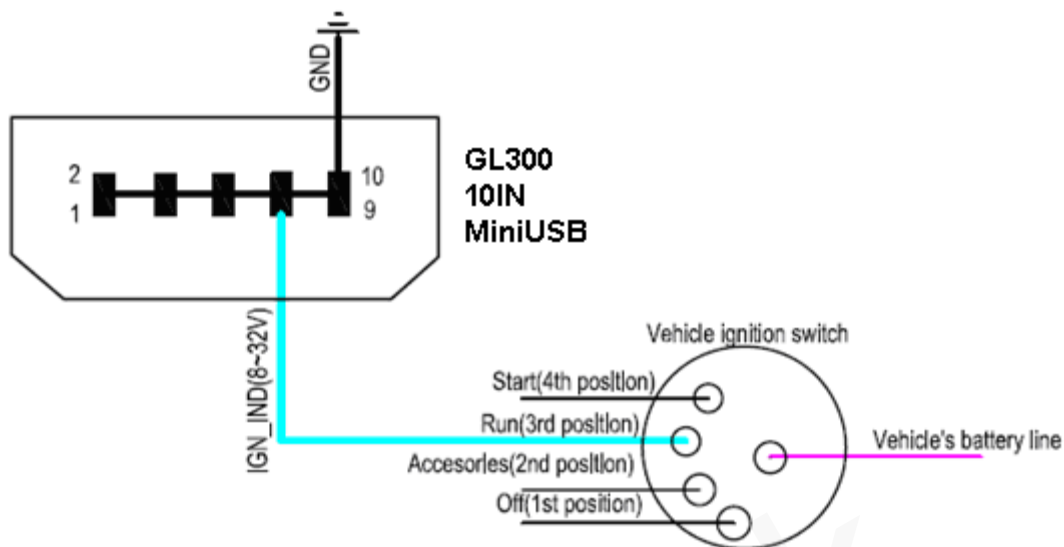

Another easy way is to connect PIN7 to a power output in the fuse box of the vehicle which is only enabled after the ignition of the vehicle is on. For example, the power output for radio FM.

## 2.6. External Input Interface

The Pin 5 on mini-USB connector is a negative trigger input in newer hardware version. It is named NSW pin.

For negative trigger input the electrical conditions are:

Logical status	Electrical status
Active	0V to 0.8V
Inactive	1.7V to 32V or open

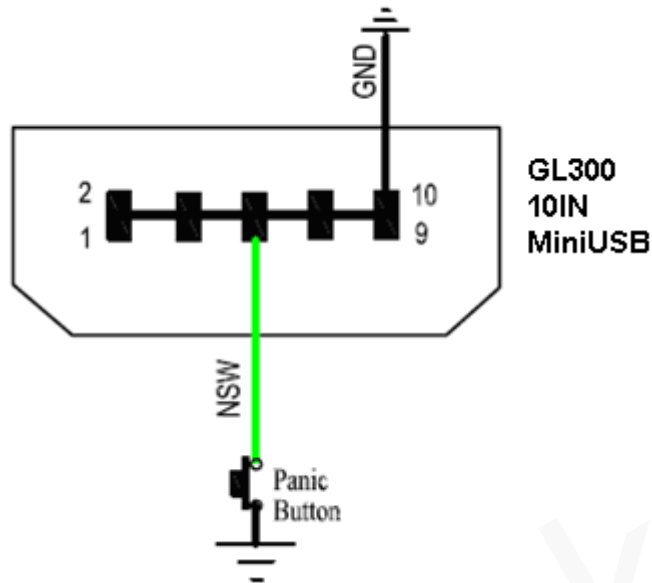

An input example is shown in the following figure:



Example of NSW Pin Connecting to a Panic Button

### 3. Get Started

#### 3.1. Parts List

Name	Picture	Remark
GL300 Locator		The GSM/GPRS/GPS locator.
AC-DC Power Adapter (Standard accessory)		It is used to charge the internal battery of GL300.
GL300 Data Cable (Optional accessory)		It is the USB data cable which can be used for firmware upgrading and configuration.
External Battery Kit (Optional accessory)		It is a set of accessories including an external battery, a power control unit and a

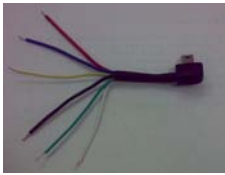
		<p>pelican waterproof casing. It will greatly improve the working time of GL300 and also let the GL300 to be used for some special applications like container tracking.</p> <p>Please refer to “GL200 External Battery Kit User Manual.pdf” for detail.</p>
<p>GL300 External Cable (Optional accessory)</p>		<p>It is the extension cable which includes the charger interface and external battery interface on GL300. It also includes the ignition detection interface on the GL300.</p>

### 3.2. Battery Charging

- Please connect AC-DC power adapter with GL300.
- Insert the AC-DC power adapter into the power socket.
- During charging, the PWR LED is flashing fast. When the battery is fully charged, the PWR LED will be normally on.
- You can also charge the battery by USB cable which connects GL300 with the PC.
- Charging time is about 5 hours.

**Note: Before the first time you use GL300, please fully charge the battery.**

### 3.3. GL300 External Cable Interface

- GL300 External Cable is a cable with a mini USB connector and six wires which include the external power interface, ignition detection and input interface for GL300. Please find the detailed description in the following table.

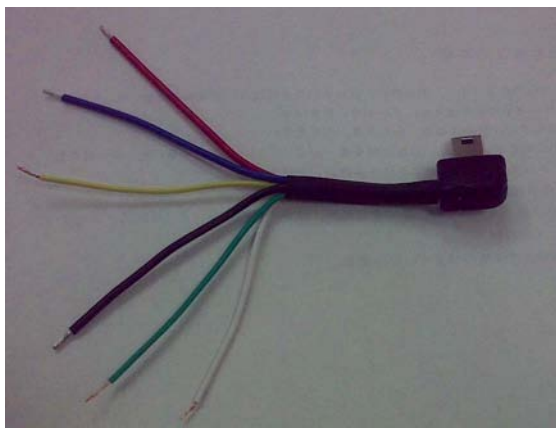

Color	Name	Remark
Red	External DC IN (5V)	Please refer to 2.4.1 for detail
Black	Ground	Please refer to 2.4.1 for detail
Blue	External Battery IN (DC 3.4V to 4.2V)	Please refer to 2.4.2 for detail
White	Ignition Detection	Please refer to 2.5 for detail
Green	NSW (negative trigger input)	Please refer to 2.6 for detail
Yellow	OUT (negative trigger output)	Please refer to 2.6 for detail

### 3.4. Install SIM Card

- First, open the cover of SIM card.
- Then insert the SIM card into the slot of SIM card according to the direction shown.
- Finally, cover the slot.

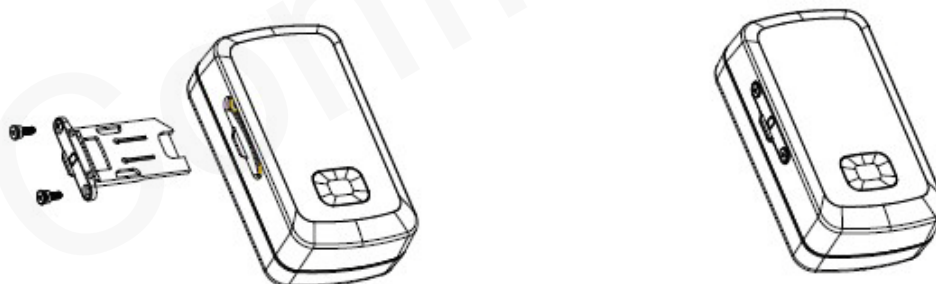

### 3.5. Turn on/Turn off

- Turn on:
  - ◆ Method 1: Keep pressing the power key for at least 3 seconds and release it to turn on GL300. At the same time, PWR LED will light up.
  - ◆ Method 2: Connect the device to charger or external battery, and it will turn on

automatically. Meanwhile, PWR LED will light up.

- Turn off:
  - ◆ Method 1: Keep pressing the power key for about 2 seconds, and PWR LED will fast flash and then turn off, which indicates that GL300 is turned off. The time of power off depends on the quality of network. The maximum time of power off is 90 seconds. It is only valid to turn off when using internal battery. Please note that the end-user can not power off GL300 when the power key is disabled by protocol.
  - ◆ Method 2: If you are using external battery, the device's power will be turned off when external battery is disconnected.

## 4. Troubleshooting and Safety Info

### 4.1. Troubleshooting

Trouble	Possible reason	Solution
After GL300 is turned on, the GSM LED always flashes quickly.	The SIM card is not inserted.	Please insert the SIM card into GL300.
	The signal is too weak; GL300 can't register to the network.	Please move GL300 into places with good GSM coverage.
	PIN locked	Use SIM card without SIM-PIN, or unlock SIM-PIN.
Messages can't be reported to the backend server by GPRS.	The SIM card in GL300 doesn't support GPRS.	Try a GPRS supporting SIM card.
	APN is wrong. Some APNs can not visit the Internet directly.	Ask the network operator for the right APN.
	The IP address or port of the backend server is wrong.	Make sure the IP address for the backend server is an identified address on the Internet.
Unable to power off GL300.	The function of power key is disabled by AT+GTSFR.	Enable the function of power key by AT+GTFKS.
	Unable to power off GL300 if charger or external battery is connected.	Disconnect charger or external battery, and try again.
No response from UART when configuring GL300 through UART	GL300 is in power saving mode.	Remove the Data_Cable_M, and plug it in again. After this operation, GL300 will exit from power saving mode and keep the state for 10 seconds.
		Re-try GL300 manager tool again, and it will try to wake up device.
GL300 can't get successful GPS fixing.	The GPS signal is weak.	Please move GL300 to a place with open sky.
		It is better to let the top surface face the sky. (The same surface with indication LED)

## 4.2. Safety Info

- Please do not disassemble the device by yourself.
- Please do not put the device on overheating or too humid place, and avoid exposure to direct sunlight. Too high temperature will damage the device or even cause battery explosion.
- Please do not use GL300 on the airplane or near medical equipment.