



GSM/GPRS/GPS Tracker **GV100**

User Manual

TRACGV100UM001

Revision: 1.01

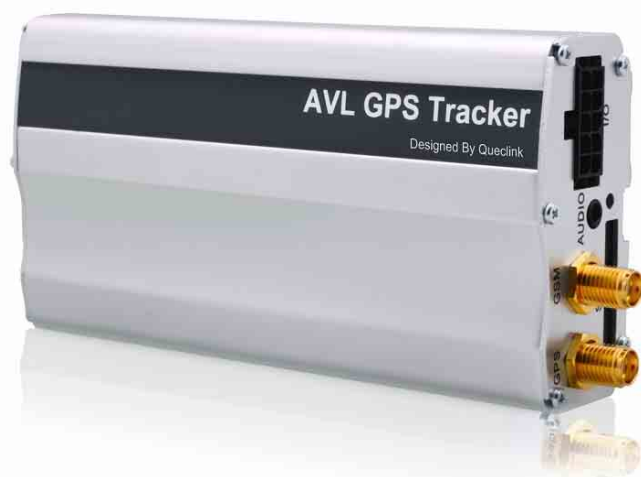

<http://www.queclink.com>

sales@queclink.com

Document Title	GV100 User manual
Version	1.01
Date	2010-07-01
Status	Initial
Document Control ID	TRACGV100UM001

General Notes

Queclink offers this information as a service to its customers, to support application and engineering efforts that use the products designed by Queclink. The information provided is based upon requirements specifically provided to Queclink by the customers. Queclink has not undertaken any independent search for additional relevant information, including any information that may be in the customer's possession. Furthermore, system validation of this product designed by Queclink within a larger electronic system remains the responsibility of the customer or the customer's system integrator. All specifications supplied herein are subject to change.

Copyright

This document contains proprietary technical information which is the property of Queclink Limited., copying of this document and giving it to others and the using or communication of the contents thereof, are forbidden without express authority. Offenders are liable to the payment of damages. All rights reserved in the event of grant of a patent or the registration of a utility model or design. All specification supplied herein are subject to change without notice at any time.

Copyright © Shanghai Queclink Wireless Solutions Co., Ltd. 2009

Contents

Contents	2
0. Revision history	3
1. Introduction.....	4
1.1. Reference.....	4
1.2. Terms and abbreviations.....	4
2. Product Overview	5
2.1. Appearance.....	5
2.2. Parts List.....	5
3. Interface Description And Installation Guide.....	7
3.1. SIM Card Interface.....	7
3.2. Antenna Interface	8
3.2.1. Install Antennas.....	8
3.2.2. GPS antenna specification.....	8
3.2.3. GSM antenna specification	9
3.3. Power Interface	10
3.3.1. Power Interface definition.....	10
3.3.2. Power connection.....	11
3.3.3. Ignition Detect.....	12
3.3.4. Ignition Control.....	13
3.4. I/O Interface	14
3.4.1. Electrical conditions for digital inputs	15
3.4.2. Digital Input without Interrupt	16
3.4.3. Digital Input with Interrupt	16
3.4.4. Analog Input.....	16
3.4.5. Digital Output.....	17
3.4.6. Digital Output with Built-in Relay.....	18
3.5. Indicator light Description	19
3.6. Audio Interface.....	20
3.7. RS232 Interface.....	22
3.8. Fasten The Device.....	23

0. Revision history

Revision	Date	Author	Description of change
1.00	2009-10-15	Edwin Peng	Initial
1.01	2010-07-01	Moon Xie	Initial

Queclink
Confidential

1. Introduction

The GV100 is a powerful GPS Locator designed for vehicle tracking or assets tracking. With superior receiving sensitivity, fast TTFF (Time to First Fix) and Quad-Band GSM frequencies 850/900/1800/1900, its location can be monitored in real time or periodically tracked by a backend server or other specified terminals. The GV100 has multiple input/output interfaces which can be used for monitoring or controlling external devices. Based on the integrated @Track protocol, the GV100 can communicate with a backend server through the GPRS/GSM network to transfer reports of Emergency, Geo-fence boundary crossings, Lower Battery or scheduled GPS position along with many other useful functions. Users can also use GV100 to monitor the status of a vehicle and control the vehicle with its onboard relay output. System Integrators can easily setup their tracking systems based on the full-featured @Track protocol.

1.1. Reference

SN	Document name	Remark
[1]	GV100 @Track Air Interface Protocol v1 00.PDF	The air protocol interface between GV100 and backend server.

1.2. Terms and abbreviations



Abbreviation	Description

2. Product Overview

2.1. Appearance



2.2. Parts List

Name	Picture
GV100 Locator	
Power Cable with fuse	

<p>I/O cable</p>	
<p>Steel Piece</p>	
<p>GPS Antenna</p>	
<p>GSM Antenna</p>	
<p>12V DC power supply (Optional)</p>	
<p>USB-232 data cable (Optional)</p>	
<p>Relay (Optional)</p>	

3. Interface Description And Installation Guide

3.1. SIM Card Interface

To install the SIM card

Step 1: Press the yellow button on the right side of SIM card slot to eject the SIM card holder.

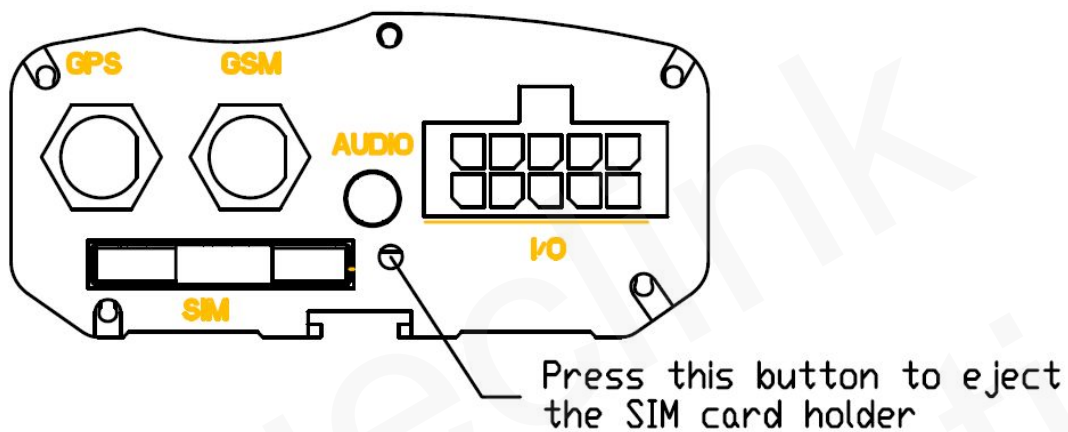

Step 2: Put the SIM card on the SIM card holder.

Step 3: Install the SIM card holder to SIM card slot. Please pay attention to the direction.

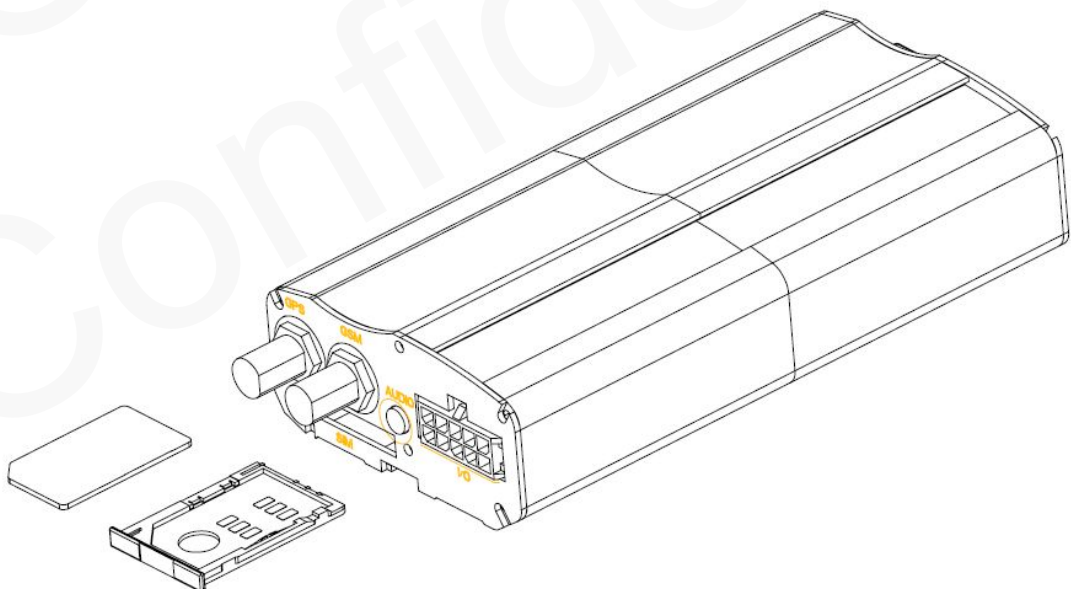

3.2. Antenna Interface

3.2.1. Install Antennas

There are two SMA antenna connectors on GV100, one for GPS and another for GSM. Please find the GSM antenna and GSM antenna in package box. Install them to the correct SMA connector like following.

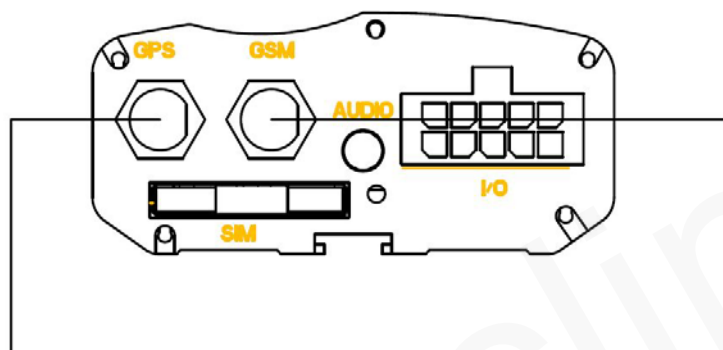

3.2.2. GPS antenna specification

GPS antenna:	Frequency: 1575.42MHz
Bandwidth:	>5MHz
Beamwidth:	>120 deg
Supply voltage:	3.3V
Polarization:	RHCP or Linear
Gain:	Passive: 0dBi minimum Active: 15dB
Impedance:	50Ω
VSWR:	< 2
Noise figure:	<3

3.2.3. GSM antenna specification

GSM antenna specification	
Frequency and bandwidth	GSM850: 824MHz to 894MHz; EGSM900: 880MHz to 960MHz; DCS1800: 1710MHz to 1885MHz; PCS1900: 1850MHz to 1990MHz;
Direction:	Omnidirection;
Gain:	Passive: >0dBi;
Impedance:	50Ω;
VSWR:	<4;
Efficient:	GSM850: >40%; EGSM900: >40%; DCS1800: >30%; PCS1900: >30%;

3.3. Power Interface

3.3.1. Power Interface definition

There are four Pins on power connector:

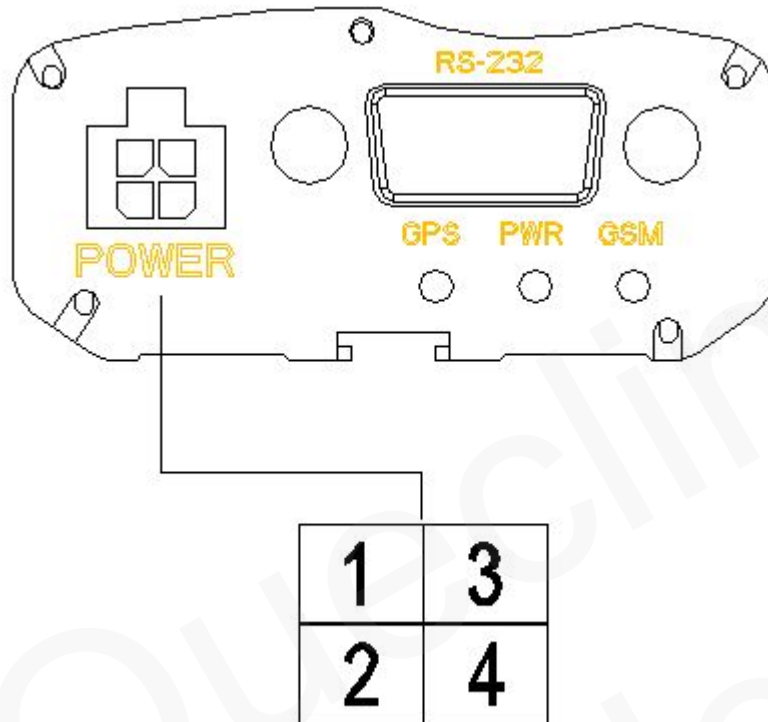

Index	Color of power cable	Description	Recommended Function
1	Red	Power (+8V ~ 32V)	Power
2	Black	Ground	Ground
3	Yellow	Input 1 (Digital , Positive Trigger)	Ignition Key Detect
4	White	Digital Output 1 (Negative Trigger)	

3.3.2. Power connection

The input voltage range of GV100 is 8V to 32V DC and can be connected to vehicle's battery directly (12V or 24V DC). Please install the power like following.

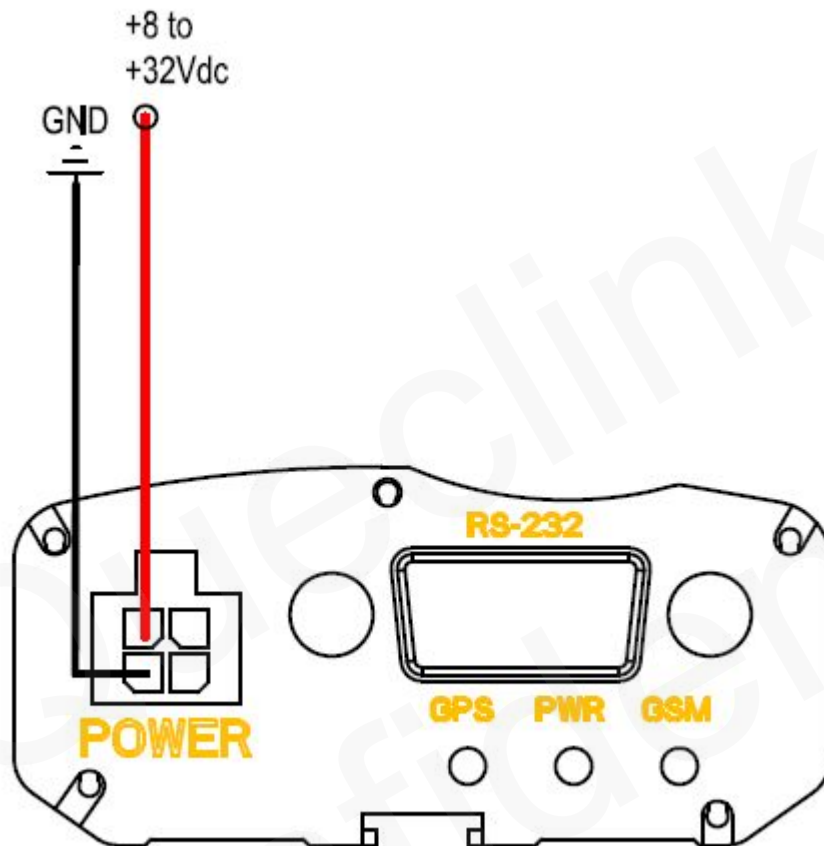

3.3.3. Ignition Detect

The PIN 3 of power connector is Input 1 (Digital, Positive trigger). Its electrical conditions are:

Logical State	Electrical State
Active	5.0V to 32V
Inactive	0V to 3V or Open

It is strongly recommended to connect this pin to ignition key to support the power saving function when the vehicle is off. Please note input 1 does not have interrupt and the recommended sample rate is 3 seconds.

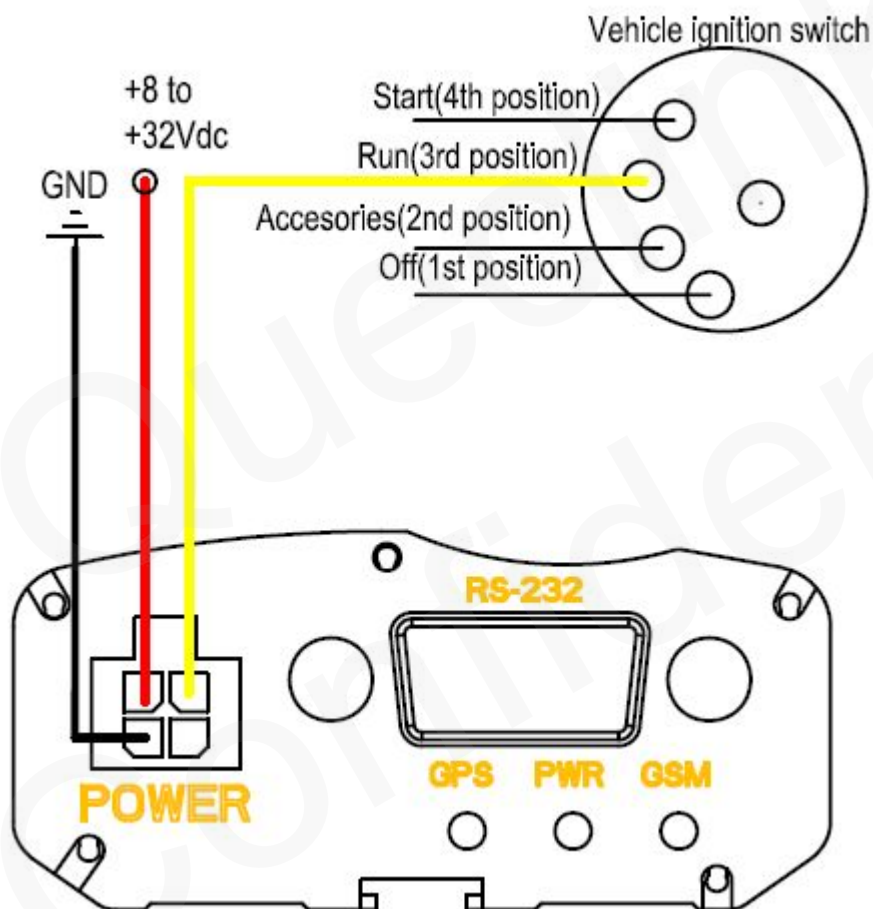

3.4. I/O Interface

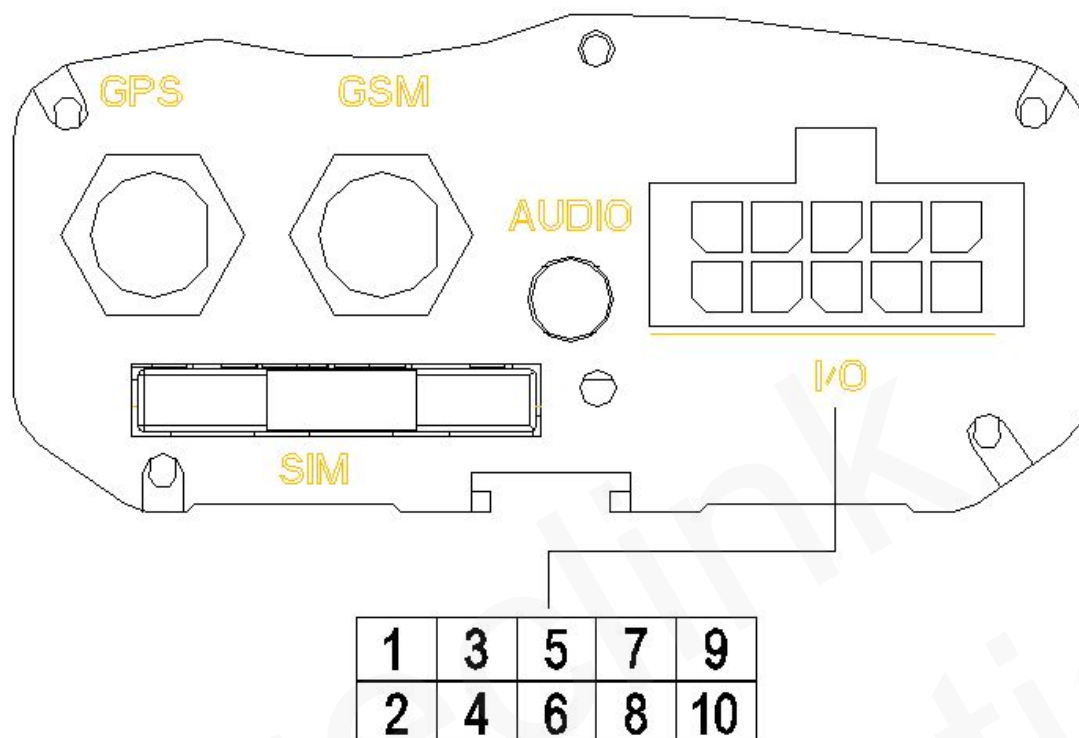

There are several inputs and outputs on I/O cable and the definition are:

Index	Color on I/O cable	Description	Recommended Function
1	White	Input 2 (Digital , Positive Trigger)	
2	Black	Input 3 (Digital , Positive Trigger, With interrupt)	
3	Brown	Input 4 (Digital , Negative Trigger, With interrupt)	Panic Button
4	Yellow	Input 5 (Digital , Negative Trigger)	
5	Gray	Input 6 (Analog, Input voltage range : 0 – 28 V)	
6	Purple	Digital Output 2 (Negative Trigger)	
7	Red	Digital Output 3 (Negative Trigger)	
8	Green	Digital Output 4 (Negative Trigger)	
9	Orange		
10	Blue	Digital Output 5 (Built in Relay)	

3.4.1. Electrical conditions for digital inputs

For negative trigger inputs the electrical conditions are:

Logical State	Electrical State
Active	0V to 0.8V
Inactive	1.7V to 32V or Open

For positive trigger inputs the electrical conditions are:

Logical State	Electrical State
Active	5.0V to 32V
Inactive	0V to 3V or Open

The example connections are showed in following figure:

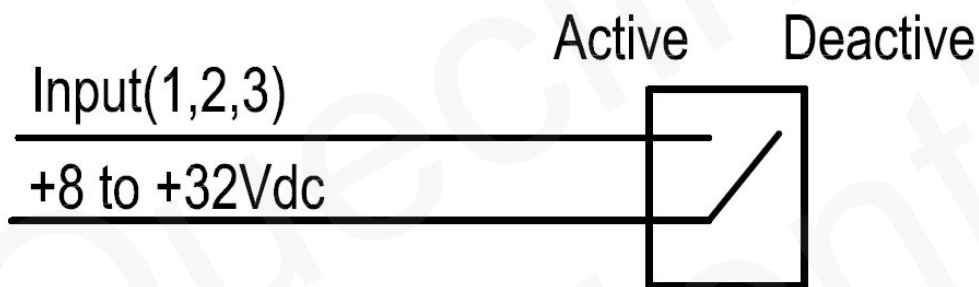

Example connection for Positive Trigger digital inputs

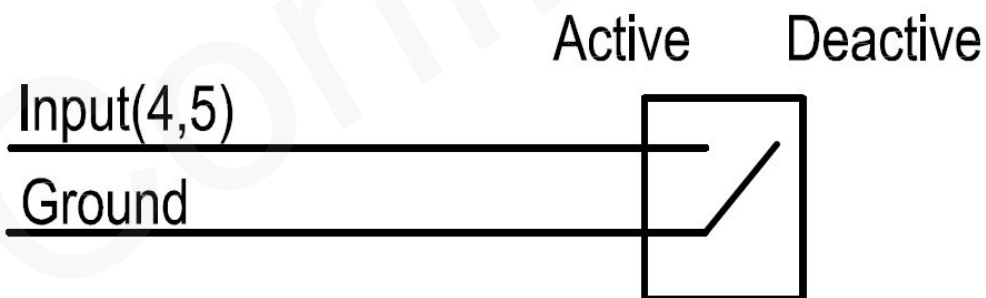

Example connection for Negative Trigger digital inputs

3.4.2. Digital Input without Interrupt

Input 2 and input 5 are digital inputs which do not have interrupt. The sample rate for these two digital inputs is 100ms to 25 seconds. The recommend sample rate is 3 seconds. Please note the high sample rate will also result in high power consumption. Input 2 is positive trigger and Input 5 is negative trigger.

3.4.3. Digital Input with Interrupt

Input 3 and input 4 are digital inputs which have interrupt. Input 3 is positive trigger and input 4 is negative trigger.

The example connections are same as showed in chapter 3.4.1.

Input 4 is also recommended to support panic button function and the connection is showed as following.

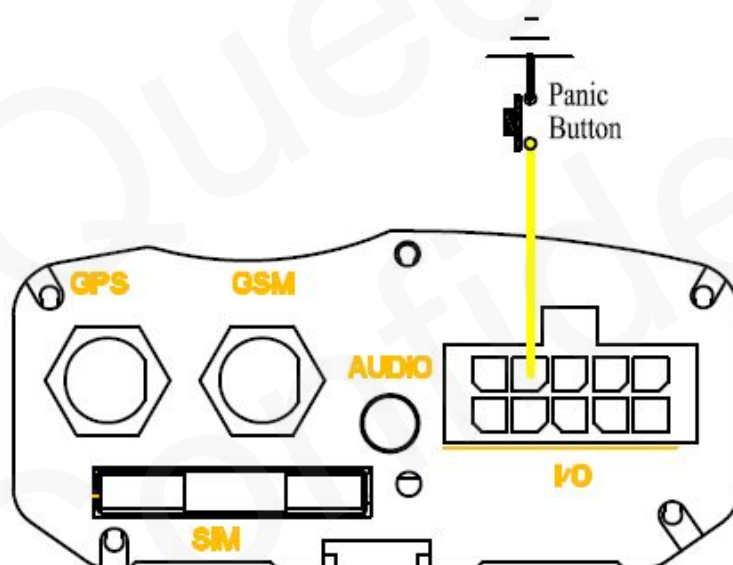

3.4.4. Analog Input

The pin 5 of I/O cable is used for analog to digital converter. The input voltage range is 0V to 28V and can tolerant 32V voltage. Please note it is an average value based on the sample rate of 10 seconds, which means the bust on voltage input may not be detected.

3.4.5. Digital Output

The outputs are Open-Drain type with no internal pull-up resistor which also be used to control a relay. It means that the user has to connect a pull-up resistor or a relay coil between the Output pin and any positive voltage (32V max.) to generate a correct output.. Each output can drive a continuous current of 0.2A.

The electrical conditions are:

Logical State	Electrical State
Enable	<1.5V, max current is 0.2A
Disable	Open or the pull-up voltage (max 32V)

The outputs are used for cutting/restoring GND. The example connections are:

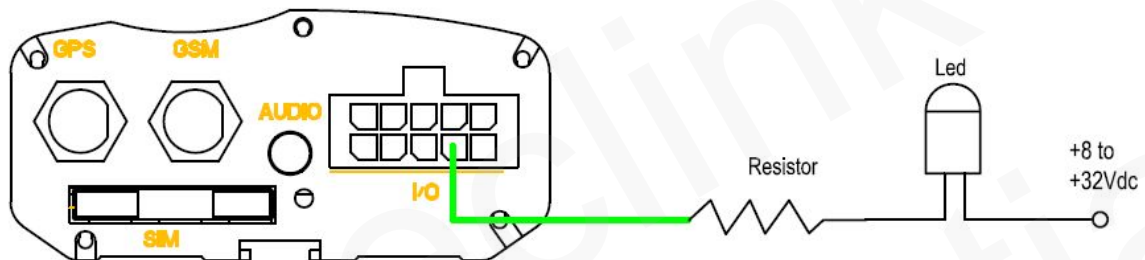

The example connection to drive a LED

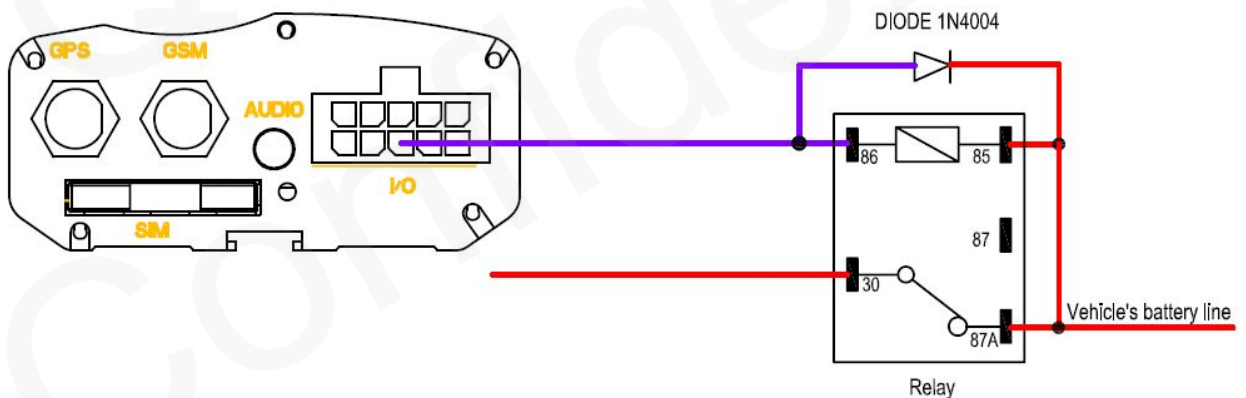

The example connection to drive a Relay

If the digital output is used to drive a relay, a catch diode is showed across the relay coil, this is necessary to prevent damage to the digital output when the relay is turned off. Many modern relays come with this diode pre-installed internal to the relay itself. If the relay has this diode, insure the proper relay polarity connected is used. If this diode is not internal, it should be added externally. A common diode such as a 1N4004 will work in most circumstances.

3.4.6. Digital Output with Built-in Relay

The build in relay output is Open-Drain type with no internal pull-up resistor. It means that the user has to connect a pull-up resistor to any positive voltage to generate a correct output. The switch capacity of the relay contact is 60W, so it can drive a continuous current of 2A at the input voltage of 30V and 1.85A at the input voltage of 32V.

The electrical conditions are:

Logical State	Electrical State
Enable	0V
Disable	Open or the pull-up voltage (max 32V)

The output is used for cutting/restoring GND. It can be directly drive a LED and the example connection is showed as following.

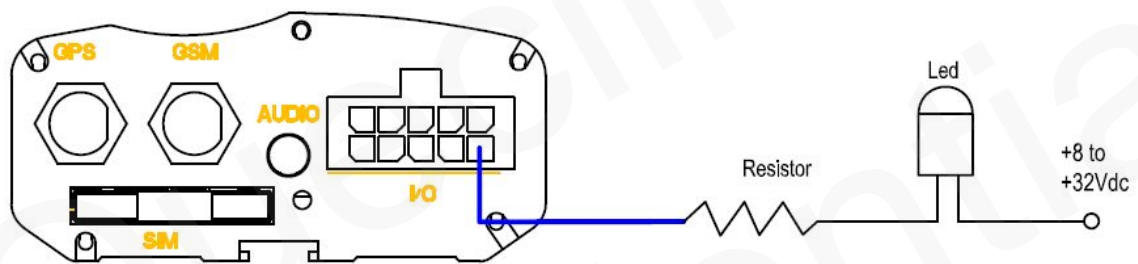

3.5. Indicator light Description

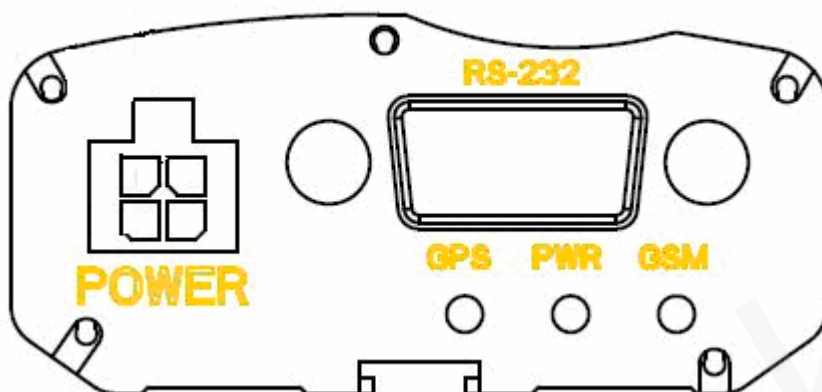

There are three LED in GV100, the description as following.

Light	Event	State
GPS LED	Stop GPS LED. And the LED will normally work for 30 minutes before they are finally stopped.	Closed
	Stop GPS LED. Within 30 minutes after boot, GPS is on need mode, no positioning requirements.	
	Start GPS LED. And no positioning requirements.	
	Start GPS LED. GPS normally work and power-saving enable, Once detected, close the GPS static or flameout	
	NEMA check fail.	Slow light
	Data invalid or no data.	
	GPS is in fixing.	Fast light
	GPS has fixed.	Ever-light
PWR LED	Stop Power LED. And the LED will normally work for 30 minutes before they are finally stopped.	Closed
	Disable backup battery, the normal internal battery and power.	
	Disable backup battery, internal battery is low.	Slow flash
	Enable backup battery, the device is in charging.	Fast flash
	Enable backup battery, charging has completed.	Ever-light
GSM LED	Network searching.	Fast flash
	SIM pin locked.	
	Network has been registered.	Slow flash

3.6. Audio Interface

The audio connector is designed to connect a non-balanced hands-free audio system. It is designed to use a 2.5mm stereo plug with the following configuration, please pay attention to the common GND, this common GND is used only for audio ground, it should not be used as a power ground. The speaker interface can be connected to a 32ohm speaker or an audio amplifier which drive a louder speaker. The electret microphone is recommended.

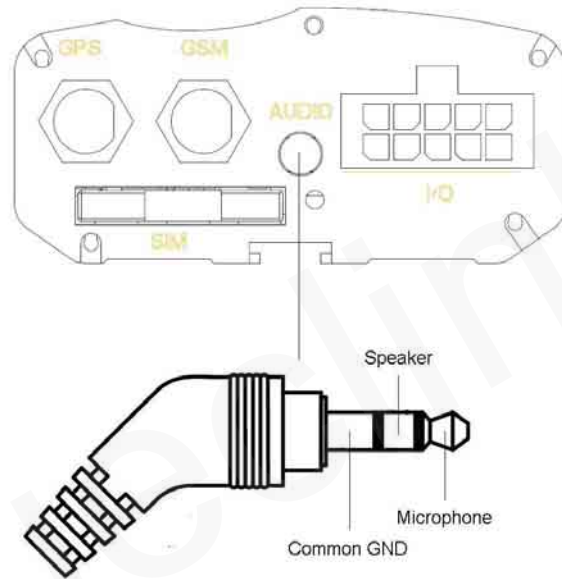

Audio Jack Interface Definition

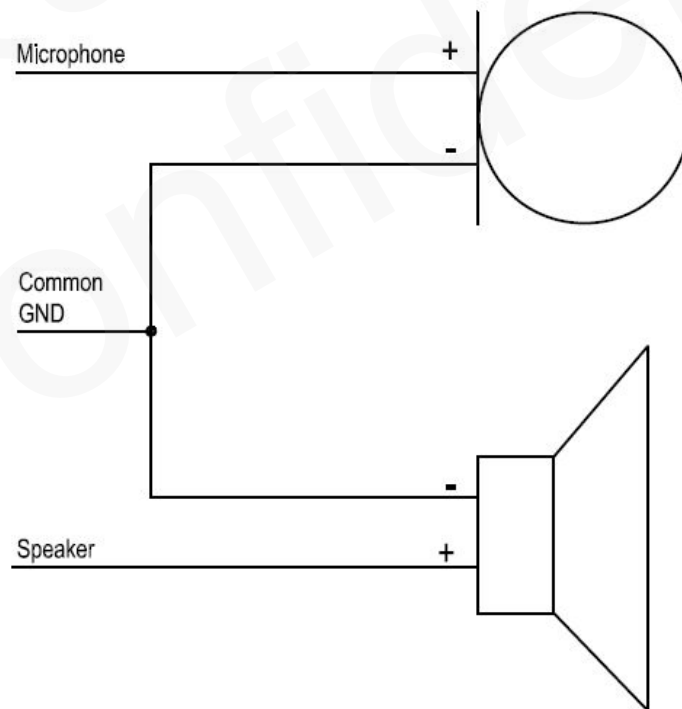

Example connection for audio

Microphone input characteristics

Parameter	Min	Typ	Max	Unit
Working Voltage	1.0	1.5	2.0	V
Working Current	200		500	uA
External Microphone Load Resistance		2.2		k Ohm

Speaker output characteristics

Parameter	Min	Typ	Max	Unit
Speaker load Resistance	16	32		Ohm
Speaker output level	0		2.4	Vpp
Maxim driving current limit of speaker			50	mA

3.7. RS232 Interface

An RS232 interface has been implemented on GV100 and it can be used to configure the runtime parameters of GV100.

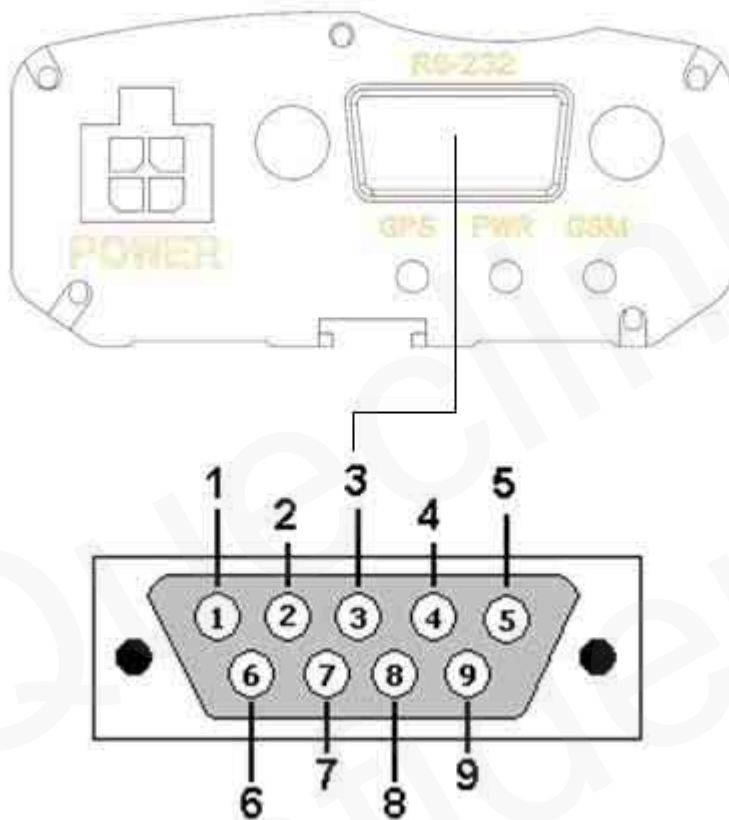

RS232 DB-9 Connector Pin Description (PC side)

Pin Index	Signal Name	Signal Description
1	CD	Carrier Detect
2	RXD	Receive Data
3	TXD	Transmit Data
4	DTR	Data Terminal Ready
5	GND	Ground
6	None	None
7	RTS	Request To Send
8	CTS	Clear To Send
9	RI	Ring Indicator

3.8. Fasten The Device

Please use the steel piece and screw to fasten the device.

