

# CR Family Hardware Installation Guide



Cellocator Division  
Pointer Telocation Ltd.

Proprietary and Confidential

Version 1.0

Revised and Updated: May 20, 2014



**POINTER**



## CR200 Hardware Installation Guide



### Legal Notices

#### IMPORTANT

1. All legal terms and safety and operating instructions should be read thoroughly before the product accompanying this document is installed and operated.
2. This document should be retained for future reference.
3. Attachments, accessories or peripheral devices not supplied or recommended in writing by Pointer Telocation Ltd. may be hazardous and/or may cause damage to the product and should not, in any circumstances, be used or combined with the product.

#### General

The product accompanying this document is not designated for and should not be used in life support appliances, devices, machines or other systems of any sort where any malfunction of the product can reasonably be expected to result in injury or death. Customers of Pointer Telocation Ltd. using, integrating, and/or selling the product for use in such applications do so at their own risk and agree to fully indemnify Pointer Telocation Ltd. for any resulting loss or damages.

#### Warranty Exceptions and Disclaimers

Pointer Telocation Ltd. shall bear no responsibility and shall have no obligation under the foregoing limited warranty for any damages resulting from normal wear and tear, the cost of obtaining substitute products, or any defect that is (i) discovered by purchaser during the warranty period but purchaser does not notify Pointer Telocation Ltd. until after the end of the warranty period, (ii) caused by any accident, force majeure, misuse, abuse, handling or testing, improper installation or unauthorized repair or modification of the product, (iii) caused by use of any software not supplied by Pointer Telocation Ltd., or by use of the product other than in accordance with its documentation, or (iv) the result of electrostatic discharge, electrical surge, fire, flood or similar causes. Unless otherwise provided in a written agreement between the purchaser and Pointer Telocation Ltd., the purchaser shall be solely responsible for the proper configuration, testing and verification of the product prior to deployment in the field.

POINTER TELOCATION LTD.'S SOLE RESPONSIBILITY AND PURCHASER'S SOLE REMEDY UNDER THIS LIMITED WARRANTY SHALL BE TO REPAIR OR REPLACE THE PRODUCT HARDWARE, SOFTWARE OR SOFTWARE MEDIA (OR IF REPAIR OR REPLACEMENT IS NOT POSSIBLE, OBTAIN A REFUND OF THE PURCHASE PRICE) AS PROVIDED ABOVE. POINTER TELOCATION LTD. EXPRESSLY DISCLAIMS ALL OTHER WARRANTIES OF ANY KIND, EXPRESS OR IMPLIED, INCLUDING WITHOUT LIMITATION ANY IMPLIED WARRANTIES OF NON-INFRINGEMENT, MERCHANTABILITY, SATISFACTORY PERFORMANCE AND FITNESS FOR A PARTICULAR PURPOSE. IN NO EVENT SHALL POINTER TELOCATION LTD. BE LIABLE FOR ANY INDIRECT, SPECIAL, EXEMPLARY, INCIDENTAL OR CONSEQUENTIAL DAMAGES (INCLUDING WITHOUT LIMITATION LOSS OR INTERRUPTION OF USE, DATA, REVENUES OR PROFITS) RESULTING FROM A BREACH OF THIS WARRANTY OR BASED ON ANY OTHER LEGAL THEORY, EVEN IF POINTER TELOCATION LTD. HAS BEEN ADVISED OF THE POSSIBILITY OR LIKELIHOOD OF SUCH DAMAGES.



## CR200 Hardware Installation Guide



### Intellectual Property

Copyright in and to this document is owned solely by Pointer Telocation Ltd. Nothing in this document shall be construed as granting you any license to any intellectual property rights subsisting in or related to the subject matter of this document including, without limitation, patents, patent applications, trademarks, copyrights or other intellectual property rights, all of which remain the sole property of Pointer Telocation Ltd. Subject to applicable copyright law, no part of this document may be reproduced, stored in or introduced into a retrieval system, or transmitted in any form or by any means (electronic, mechanical, photocopying, recording or otherwise), or for any purpose, without the express written permission of Pointer Telocation Ltd.

### FCC Compliance Statement

#### The FCC Wants You to Know

This equipment has been tested and found to comply with the limits for a Class B digital device, pursuant to Part 15 of the FCC rules. These limits are designed to provide reasonable protection against harmful interference in a residential installation.

This equipment generates, uses and can radiate radio frequency energy and, if not installed and used in accordance with the instructions, may cause harmful interference to radio communications.

However, there is no guarantee that interference will not occur in a particular installation. If this equipment does cause harmful interference radio or television reception, which can be determined by turning the equipment off and on, the user is encouraged to try to correct the interference by one or more of the following measures:

- a) Reorient or relocate the receiving antenna.
- b) Increase the separation between the equipment and receiver.
- c) Connect the equipment to an outlet on a circuit different from that to which the receiver is connected.
- d) Consult the dealer or an experienced radio/TV technician

#### FCC Warning

Modifications not expressly approved by the manufacturer could void the user authority to operate the equipment under FCC Rules.

© Copyright 2014. All rights reserved.



# CR200 Hardware Installation Guide



## Table of Contents

<b>1</b>	<b>Introduction</b> .....	<b>5</b>
1.1	Abbreviations .....	5
1.2	References .....	5
1.3	Revision History .....	5
<b>2</b>	<b>CR Family Overview</b> .....	<b>6</b>
2.1	Introducing the Main Elements of the CR Family Unit .....	6
2.2	CR Family Unit Types .....	7
2.3	CR Family Harnesses .....	7
2.4	Overview of the Hardware Installation Elements.....	9
2.5	CR 10 wires Harness (PN 711-00328) .....	9
<b>3</b>	<b>Preparing for Installation</b> .....	<b>11</b>
3.1	Pre-Installation Information.....	11
3.2	Safety.....	11
3.3	Tools and Equipment Required .....	12
3.4	Materials Required.....	12
3.5	Installation Best Practices .....	12
<b>4</b>	<b>CR Unit Installation Instructions</b> .....	<b>17</b>
4.1	General.....	17
4.2	Location of the Device in the Vehicle.....	17
4.3	Device Orientation.....	19
4.4	Installing the SIM Card .....	20
4.5	Installing the Battery in CR B Models .....	21
<b>5</b>	<b>Harness Installation Instructions</b> .....	<b>22</b>
5.1	Harness Outputs Installation Specifications.....	22
5.2	Harness Inputs Installation Specifications.....	25
5.3	Harness Power Installation Specifications .....	26
5.4	Serial Port Connector .....	26
5.5	CR Unit Installation Diagram.....	28
<b>6</b>	<b>Post-Installation</b> .....	<b>29</b>



# CR Family Hardware Installation Guide



## 1 Introduction

This guide provides the necessary information for technicians to install the CR Family units (CR-200/B and CR-300/B). It describes how to install and verify the proper functioning of the installation kit elements.

### 1.1 Abbreviations

Abbreviation	Description
SVR	Stolen Vehicle Recovery

### 1.2 References

#	Reference	Description
1	Cellocator Evaluation Suite Manual	This document explains the unit's evaluation kit set up.
2	Cello Hardware Installation Guide	This document explains the Cello family variants installation instructions and good practices.
3	<a href="#">CR200 Release Notes</a>	This document describes the relevant technical aspects of the CR200.
	CR300 Release Notes	This document describes the relevant technical aspects of the CR300.
4	<a href="#">Cellocator Fuse Harness Overview</a>	This document describes the relevant technical aspects of the Fuse Harnesses.
5	<a href="#">Battery Handling Procedure for Cellocator Units</a>	This document describes how to handle batteries during storage and transportation.

### 1.3 Revision History

Version	Date	Description
1.0	May 20, 2014	Initial version.

## 2 CR Family Overview

### 2.1 Introducing the Main Elements of the CR Family Unit

Figure 1 below shows the main elements of a CR unit.

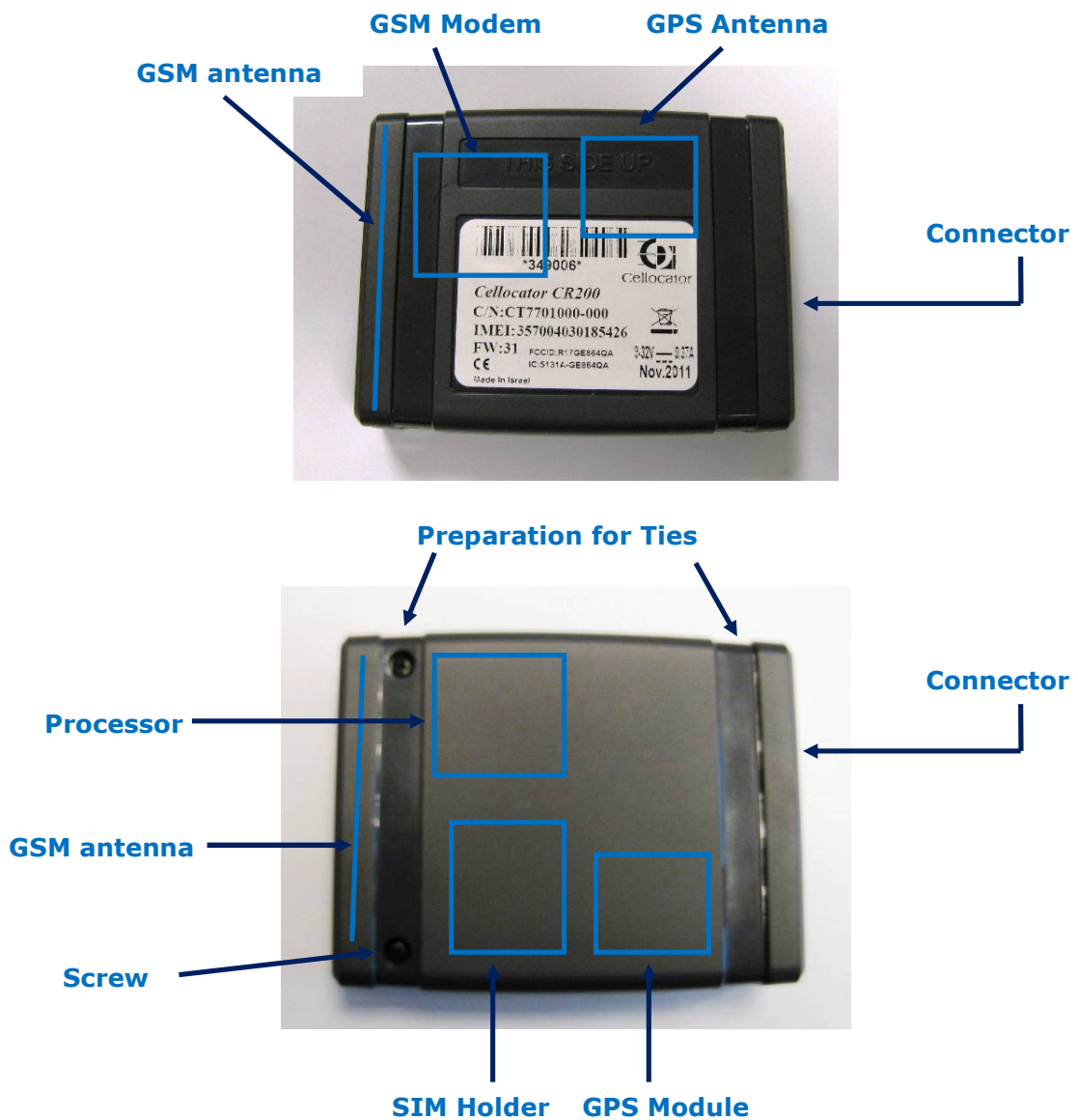

Figure 1: Main Elements of a CR unit

Figure 2 provides an internal view of the CR unit and all relevant elements.

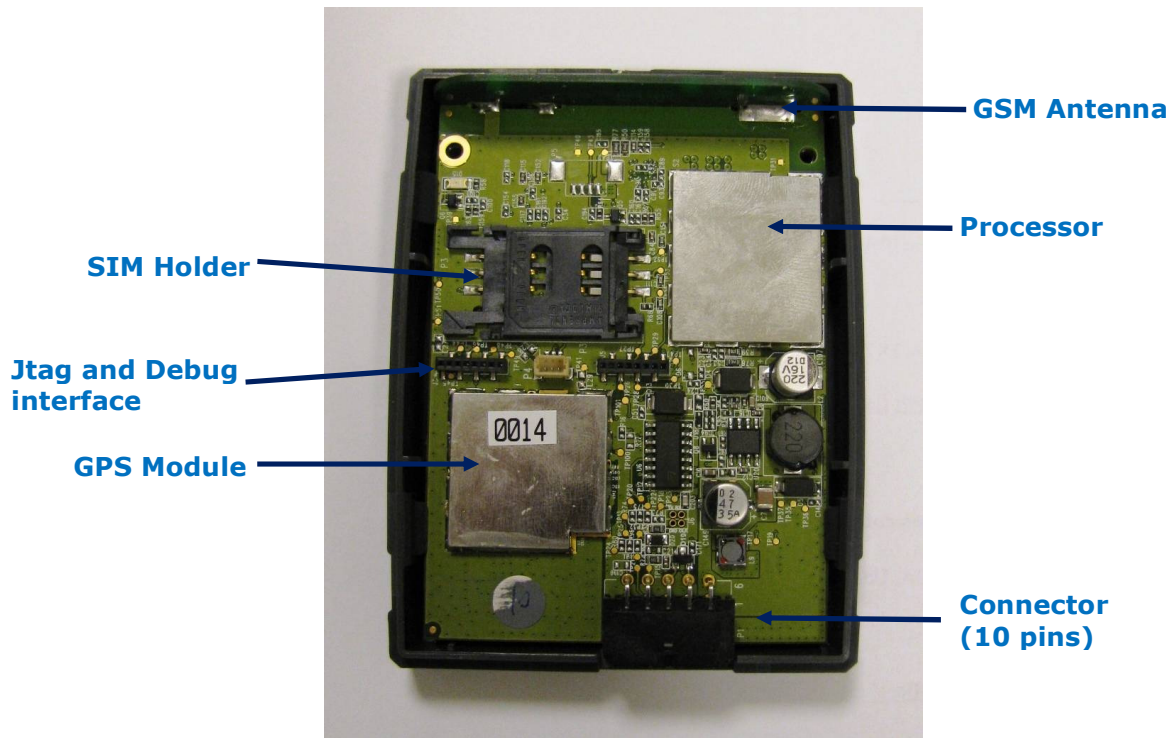

Figure 2: CR unit – Internal View

## 2.2 CR Family Unit Types

The CR Family includes the CR-200, CR-200B, CR-300 and CR-300B. The CR variants are advanced integrated GPS/GPRS units designed for fleet management and SVR applications. The unit includes also GNSS receiver and a 32-bit processor and memory providing storage for generated events.

The CR-200B and CR-300B includes also a battery which provides a better solution for SVR applications.

## 2.3 CR Family Harnesses

The CR units support the following harnesses:

- ◆ 711-00276 CR Six wires main harness.
- ◆ 711-00301 CR Family 6 Wires mold Harness. The harness is replaced by the 711-00331 CR Family 7 Wires mold Harness
- ◆ 711-00280 CR Family Fuse Harness
- ◆ 711-00331 CR Family 7 Wires mold Harness
- ◆ 711-00328 CR Family 10 Wires mold Harness

This document explains in detail how to use the 711-00328 CR Family 10 Wires mold Harness Kit for proper installation.

Please refer to [Cellocator Fuse Harness Overview](#) for installation instructions for the Fuse Harnesses.



## CR Family Hardware Installation Guide



---

### **IMPORTANT:**

- The CR unit must be protected by means of a 3A fast blow fuse. The fuse should be installed either between Power Input (Pin 1) and the vehicle battery or between the GND Input (Pin 6) and the vehicle ground.
  - The CR unit must be protected by means of PTC for safety certification compliance. The PTC should support Resettable Fuse 60V and  $I_{max}=40A$ . It should be installed between Power Input (Pin 1) and the vehicle battery.
  - These means of protections are supported by the by the fuse attached to the harnesses provided by Cellocator.
  - It is the installer responsibility to provide these means of protection if the fuse provided by Cellocator is not used.
-









## CR Family Hardware Installation Guide



### 2.4 Overview of the Hardware Installation Elements

The CR Hardware Installation requires the items listed in Table 1.

*Table 1: CR Hardware Installation Elements*

Name/Part Number	Description	Picture
<b>Cellocator CR Family Unit</b>	CR unit. Includes built in GSM modem and GPS/GNSS receiver. The CR B models include also a battery.	
<b>Vehicle harness</b> PN 711-00276	Six wires harness for vehicle installation.	
<b>CR two wires Fuse Harness</b> PN 711-00280	Two wires fuse harness for power only fast installation.	
<b>CR Family 7 Wires mold Harness</b> PN 711-00331	7 wires Harness, which supports the CR Family Protector, and can be used for all CR variants	
<b>CR Family 10 Wires mold Harness Kit</b> PN 711-00328	10 wires harness, which supports all CR300 interfaces and used mainly for CR300 variants.	

### 2.5 CR 10 wires Harness (PN 711-00328)

Cellocator provides the 712-00328 CR Family 10 Wires mold Harness mainly for the CR-300 where serial interface (pin 7&8) or Dallas (pin 10) interfaces are required. In other



## CR Family Hardware Installation Guide



cases the 711-00331 CR Family 7 Wires mold Harness can be used. The harness is made up of colored 22AWG wires, 1.2 meters long, utilizing a 10-pin connector that links to the CR unit and a 4 pins connector for the serial interface. A fuse holder with 3A fuse and PTC Resettable Fuse 60V and  $I_{max}=40A$  is attached to the harness.

The following table provides a description of the harness. Additional information can be found in the relevant sections dealing with the harness installation instructions.

*Table 2: CR 10 Wires Harnesses description*

Wire Number	Name	Wire Color	CR Unit Pin Number	Function
W1	Main Power	Red	1	Main Power
W2	GND	Black	6	Ground
W3	Ignition	Violet	4	Ignition
W4	SHOCK	Yellow	9	General Purpose Input
W5	LED	Green	2	General Purpose output or LED
W6	Global Output	Brown	3	General Purpose output.
W8	DOOR	Pink	5	General Purpose output.
W9	DALLAS	Grey	10	1-Wire interface
P2(2)	TX		7	Serial TX
P2(3)	RX		8	Serial RX

**NOTE:** DOOR and DALLAS are supported only by the CR-300



## CR Family Hardware Installation Guide



### 3 Preparing for Installation

The following section explains the pre-installation steps you should perform before installing the CR unit.

#### 3.1 Pre-Installation Information

-----  
**IMPORTANT:**

- You must be a certified technician and qualified to install the Cellocator unit.
  - Please make sure you have the correct documentation for the devices you install. The devices and documentation change frequently, which may impact the installation procedures.
  - Make sure you know the installation procedures and restrictions of the vehicle; consult with the dealer or manufacturer to get any specific instructions. These may refer to locations in the vehicle where you can install the device, connections to the electrical system, use of fuses, etc. Not following these instructions and restrictions may create false alarms and malfunctions in the vehicle systems and may even void the vehicle warranty.
  - Modern vehicles have many computerized systems that may be sensitive to radio transmissions from the device you install and may also generate interferences to the device. Carefully read the manufacturer's instructions and restrictions regarding these systems.
- 

#### 3.2 Safety

-----  
**WARNING:**

- Use protective goggles during the installation.
  - Disconnect the vehicle battery during installation. Working on live wires can be dangerous and can, for example, result in airbags inflating or fuses burning out. Some devices (e.g. the radio) may require reprogramming after a power disconnect.
  - Do not install any wires (except the fuel sensor wires) near the fuel system or fuel pipes. Make sure you never work near the fuel system with the battery connected.
  - Installation in vehicles with computerized systems may have unexpected results. Please consult with your local car dealer before performing any vehicle OEM invasive installation.
  - Do not disconnect any connectors in the vehicle while the ignition switch is turned on. This may result in damage to sensitive vehicle subsystems.
  - Use special care when handling the backup battery of the Cellocator unit. Refer to Section **Error! Reference source not found.** for details.
-

### 3.3 Tools and Equipment Required

To correctly install the device and accessories, you may need the following equipment and tools:

- ◆ A wire cutter
- ◆ Pliers (2 sizes may be required)
- ◆ Screwdrivers of several sizes
- ◆ Professional insulation remover
- ◆ Crimping tool for wire lugs
- ◆ Digital multi-meter
- ◆ Utility (razor) knife
- ◆ Flash light or other light source
- ◆ Tools to remove the vehicle trims (panel popper, sockets, ratchet etc.)

### 3.4 Materials Required

- ◆ Soldering wire
- ◆ Insulation tape of good quality (which can withstand the high temperatures in a vehicle on a hot summer day)
- ◆ Wire lugs with star washers
- ◆ Grommets, plastic tubes – as needed



Figure 3: Materials Required

### 3.5 Installation Best Practices

This section lists the Best Practices you should follow for installing the unit.

- ◆ Put protective covers on the front seats before you start the installation, to prevent damage to the upholstery. Use other covers for sensitive areas in the vehicle (LCD display, radio etc.).

- ◆ Do not use a cutter to expose the conductor in the wire, use a professional insulation remover that will not damage the delicate copper conductors.
- ◆ Use soldering for all of your connections. Do not connect a new wire to an existing wire (without soldering it) to make a connection. These types of connections, as shown in the following picture, are typically of poor quality and sooner or later will disconnect or will make intermittent connections.

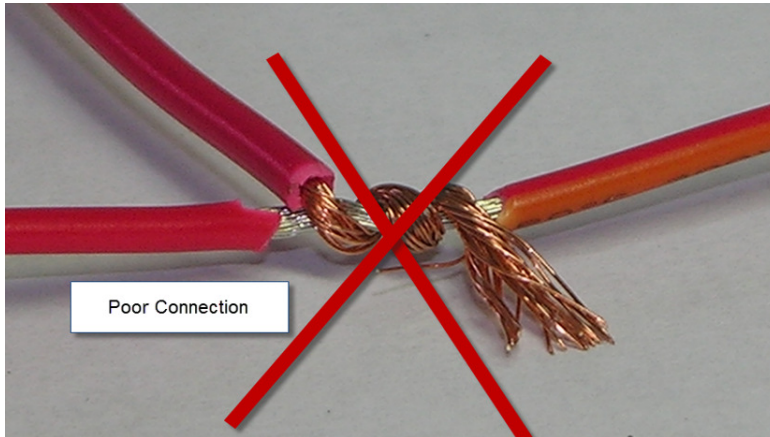

*Figure 4: Poorly Soldered Connection*

A good connection has to be properly soldered, as in the picture below:

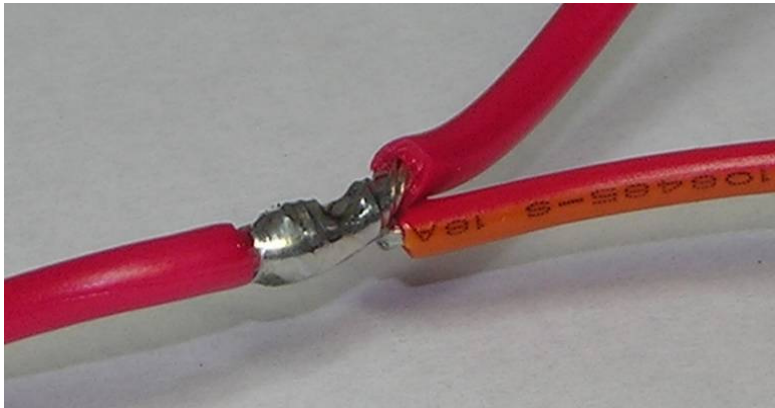

*Figure 5: Correctly Soldered Connection*

- ◆ Isolate the connection with a plastic cover or a professional insulation tape so that no wires remain exposed.



*Figure 6: Isolate the Connection*

- ◆ Use existing wire ducts, openings and holes to pass wires between different areas in the vehicle. Do not punch or drill new openings or holes to pass wires between different zones in the vehicles, as this will create permanent damage to the vehicle, and other wires or pipes. Make sure the opening is properly protected by a grommet or a plastic sleeve to prevent damage to the wires.

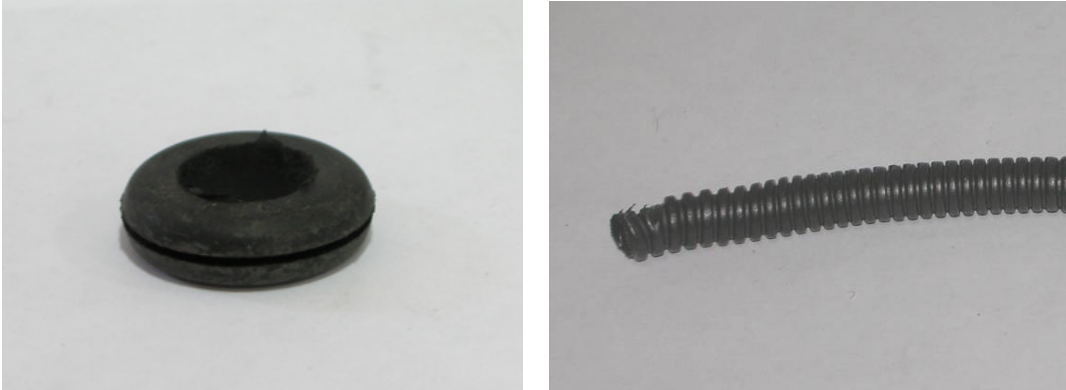

*Figure 7: Preventing damage to the wires*

- ◆ Use only a voltmeter or LED based test lamp (that uses a very small current) to test the existence of voltage in a wire or accessory. Do not use a regular test lamp to test the existence of voltage in a wire. These testers take quite a lot of current and may damage the equipment in the vehicle (for example it can trigger an airbag or damage a communication bus).
- ◆ When you want to test the voltage on a wire, do not expose the existing wires or use a sharp edge to make an electrical connection to a wire through the insulation sleeve around it. Make the connection at the end of the wire, near the connector.
- ◆ Do not insert the multi-meter probe tip into the female pin in the connector. This may widen it and prevent a proper connection when the male connector is plugged in.

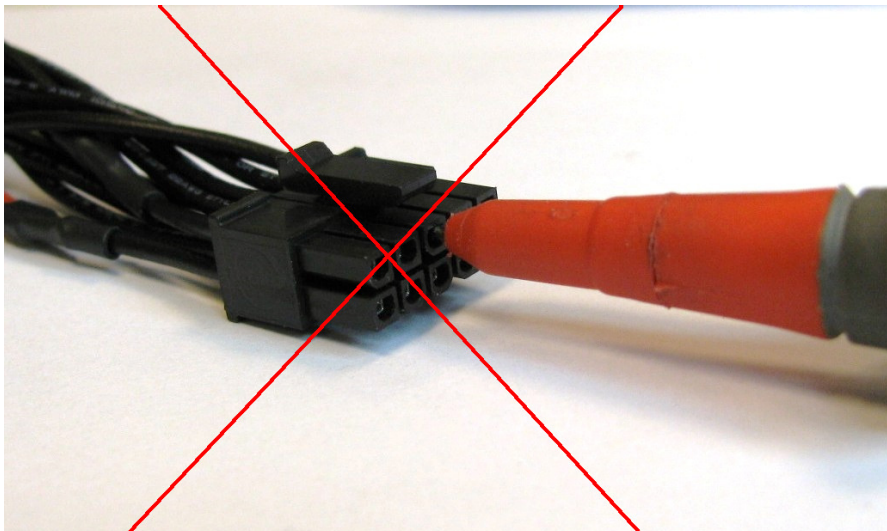

*Figure 8: Incorrect probe insertion*

The correct way to connect the probe of a voltmeter or tester to the connector is shown below:

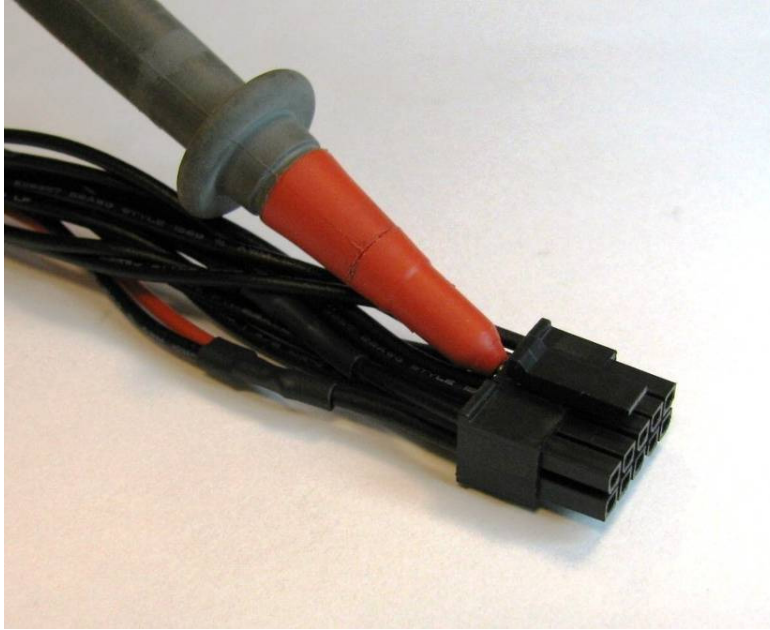

*Figure 9: Correct connection*

- ◆ To connect the negative power wire of the device, connect a lug properly crimped (or soldered) to the negative wire of the device (pin 3 in the 20 pin connector) and screw it to the chassis using an existing screw. Ensure the connection is good and stable.



*Figure 10: Connecting negative power wire*

- ◆ After all wires are connected, use plastic straps (cable ties) or insulation tape to secure all the wires and cables to fixed elements in the vehicle (such as existing stable cables, metal parts or other fixed parts of the vehicle, but not parts that are removed during regular vehicle service). Loose cables and wires may cause irritating noises while the vehicle is in motion.
- ◆ Do not lay cables and wires on the floor of the vehicle where people can step on them. Always route the cables in areas where they will not be stepped on or otherwise damaged by other activities.
- ◆ All wires and cables should be hidden.
- ◆ Make sure the device is receiving power with a properly fused connection. The fuse is supplied with the harness.
- ◆ To attach the device to its location use a thick, two sided, adhesive tape, between the device and the fixed support and then use two plastic straps (cable ties) to secure the device to its location. Make sure the device is well positioned and will not become loose (it may either fall or create irritating noises if not properly secured).

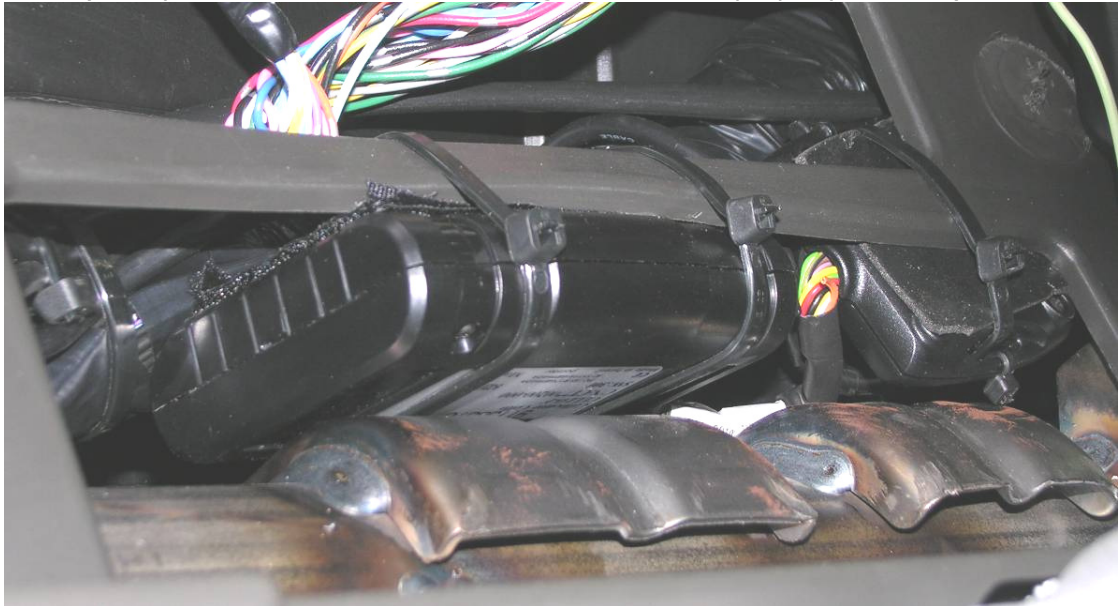

*Figure 11: Attaching the device*

- ◆ When you finish your work, clean the vehicle and return all the items you removed into their original positions, using all the original screws and connectors.
- ◆ Test the functioning of all the vehicle systems: they should all perform as is before you installed the device.
- ◆ Test the connectivity of the device with the system server to ensure proper operations.





# CR Family Hardware Installation Guide



## 4 CR Unit Installation Instructions

Before installing, please read the Pre-Installation Information and Safety sections.

### 4.1 General

The following table describes the type of vehicle in which you can install the device, and which vehicles you should NOT install it in.

Table 3: Compatible and incompatible Vehicles

You can install the device in...	Do NOT install the device in...
<ul style="list-style-type: none"><li>• <b>Passenger cars of all types</b></li><li>• <b>Light and heavy trucks</b></li><li>• <b>Buses</b></li></ul>	<ul style="list-style-type: none"><li>• <b>Motorcycles</b></li><li>• <b>Snowmobiles</b></li><li>• <b>Tractors</b></li><li>• <b>Boats, jet skis and other marine units</b></li><li>• <b>The carriage of a semi-trailer or full trailer</b></li><li>• <b>Containers and other assets</b></li></ul> <p>Installation in these environments requires special protection materials and is not covered in this guide.</p>

### 4.2 Location of the Device in the Vehicle

When locating the device in the vehicle please consider the following:

- ◆ The device is not weather proof. It is specified as an IP40 device and thus is not immune to penetration of water, rain, dust, dirt and smoke. If you need special solutions to special environmental conditions, please consult your customer support or account manager.
- ◆ The device receives and transmits radio energy in the GSM frequency bands.
- ◆ The device receives radio energy in the GPS frequency band from GPS satellites above.
- ◆ In SVR applications it is recommended to conceal the device so that it will not be easy for thieves to find and disconnect it.
- ◆ The device will not function well in excessive temperatures (see the specifications for details).
- ◆ The device requires minimal maintenance.

The following table describes both the preferred locations for installing the device and a list of locations where the device should NEVER be installed.



## CR Family Hardware Installation Guide



Table 4: Where to install the device

Preferred location in vehicle...	NEVER install the device...
<ul style="list-style-type: none"><li>• Behind the dashboard.</li><li>• In or behind the glove compartment.</li><li>• Anywhere in the front of the passenger compartment under the console and above the leg space.</li><li>• In a protected area under the driver's seat.</li><li>• Less preferable: in the trunk of a passenger car (the radio signals penetrate the trunk mostly through the rear window and rear seat: you may have to find the best location and orientation through trial and error).</li></ul>	<ul style="list-style-type: none"><li>• Outside of the passenger compartment or vehicle trunk.</li><li>• In the engine compartment.</li><li>• Inside the bumpers/fenders.</li><li>• Behind the front lights.</li><li>• In air ducts.</li><li>• Close to airbags.</li><li>• Under the vehicle.</li><li>• Under the roof of the vehicle.</li><li>• In a location susceptible to rain or water.</li><li>• Inside a metal pocket or box.</li><li>• In the loading area of a truck or pickup.</li><li>• Near the fuel tank.</li><li>• Near the wheels.</li><li>• Near any radio transmitter or its antenna.</li></ul>

Some vehicles, (for example, some Renault Kangoo models) have solar windows with transparent metallic coating that blocks the solar radiation. Unfortunately they also block most of the radio radiation required for the GPS reception. In these cases, you may consult with the dealer about the best locations for the device. If such support is not available, use trial and error to find a reasonable place for the device.

Locating the device in a prohibited location may significantly affect the functionality of the device, will shorten its lifetime and will create malfunctions and expensive service calls.

Note that the space inside the doors is not a very good location. It is more exposed to outside temperatures and will force you to install the device vertically and not horizontally. If you have to install the device there make sure to locate the device in the area that is not exposed to rain and water and has reasonable reception.

Keep at least 30 cm between the device and any computerized system in the vehicles, to avoid mutual interference.

Do not install the device or any wire near a moving or rotating part of the vehicle.

### 4.3 Device Orientation

The device uses the internal GPS antenna that should have a good GPS reception and consequently the device direction (orientation) is important. To ensure this, the side marked "This side Up" should face upwards and should have a clear sky view, unobstructed by any metal or shields. Plastic and glass do not usually affect reception.



*Figure 12: Device orientation*

The GPS receiver in the device is sensitive enough to allow reasonable reception even in cases where the top side of the device (marked 'This Side Up') deviates up to 60 degrees from the ideal direction.



*Figure 13: Ensuring the device is located with 30cm free radius*

In any case, this side should have a free space (with no metal obstructions) of approximately 30cm radius, with the device in the center of it.



## CR Family Hardware Installation Guide



### 4.4 Installing the SIM Card

To install the SIM card, perform the following steps:

**NOTE:** Make sure that your SIM card PIN is identical to the PIN programmed in the unit, or disabled. The default value of the unit PIN code is 1234. If the SIM PIN and the unit pin differ, insert the SIM card into a regular cellular phone and either change its PIN to the unit PIN (1234) or disable it.

SIM PIN protection and value (locking the SIM) can be activated automatically providing PIN synchronization between the SIM and the unit.

1. Remove the back cover of the CR unit by removing the two securing screws.

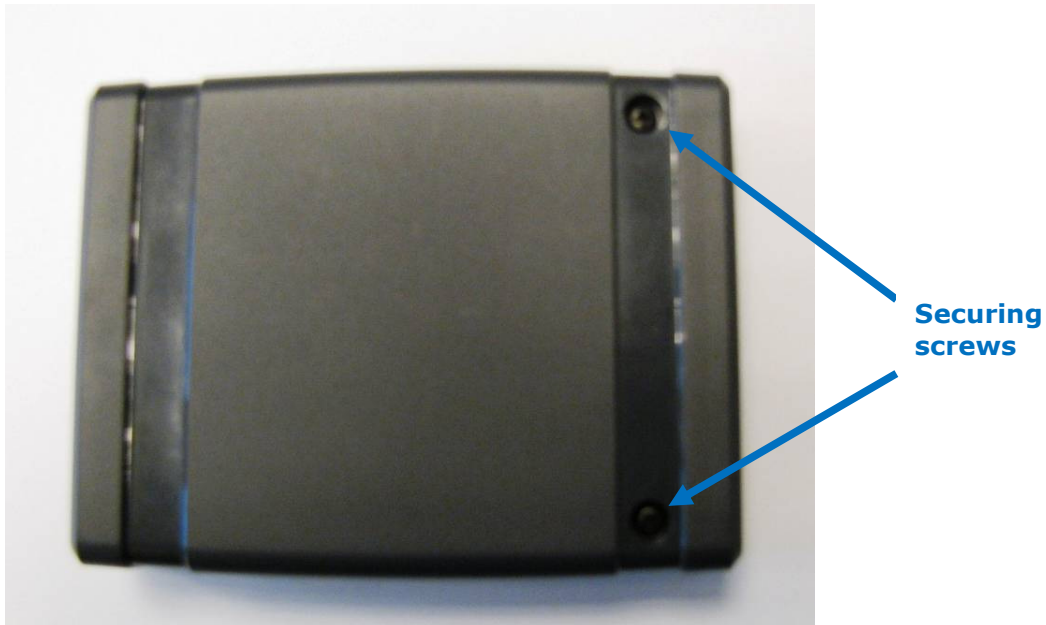

*Figure 14: Back of Unit Showing Two Securing Screws*

2. Gently slide the SIM card into the SIM holder as shown below.

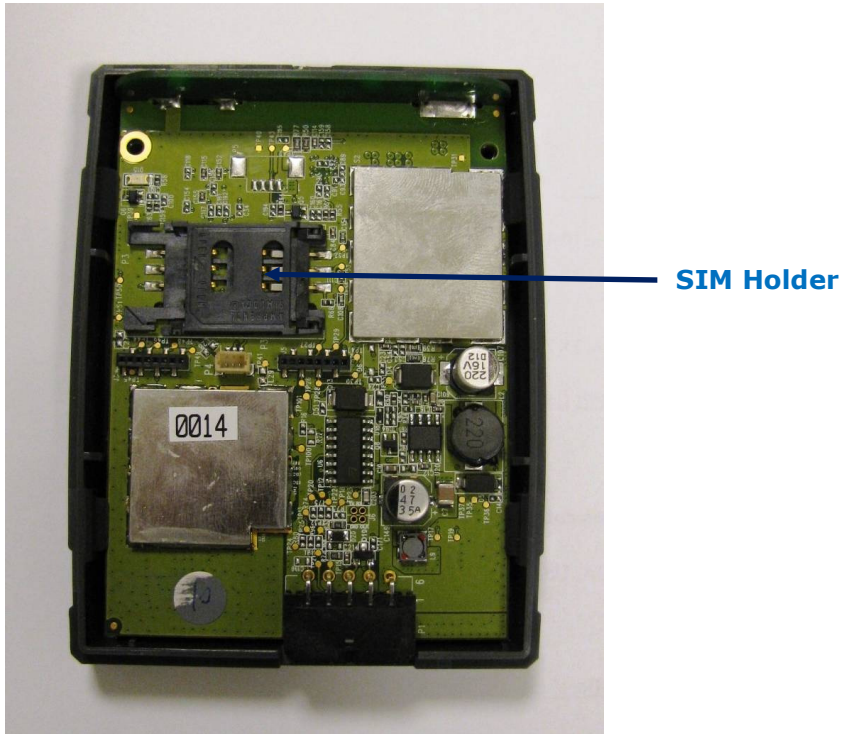

Figure 15: Inserting the SIM Card

3. Close the unit, insert the 2 screws and tighten to a torque of 3.5 kgf-cm (kilogram force per centimeter) which is approximately 0.35 Nm (Newton per Meter).

### 4.5 Installing the Battery in CR B Models

See [Battery Handling Procedure for Cellocator Units](#) for information about the battery and its handling instructions.

If you received the device without the battery or you received the device with the battery inside but not connected, please open the device, connect the battery cable to the on-board connector and close the device. When you connect the vehicle battery to the device, the device will start working normally. Do not reverse the order of connections; the correct order is to first connect the battery then connect the vehicle power to the device.

## 5 Harness Installation Instructions

### 5.1 Harness Outputs Installation Specifications

#### 5.1.1 General

The following information is common for all the outputs:

- ◆ All Outputs are Open Collector type and can sink up to 300 mA continuous.
- ◆ External devices (not OEM) that consume more than 300mA should be powered by a relay. In such cases, the output implementation requires an external relay.
- ◆ The outputs can be activated or deactivated from the control center using the OTA command.

#### 5.1.2 Relay Pin-Out

A relay is utilized to serve as an adaptor between the harness output and a device in the vehicle (immobilizer, siren, etc.). The following figure shows the pin-out location of the relay. The pin numbers are also printed on the Relay itself.

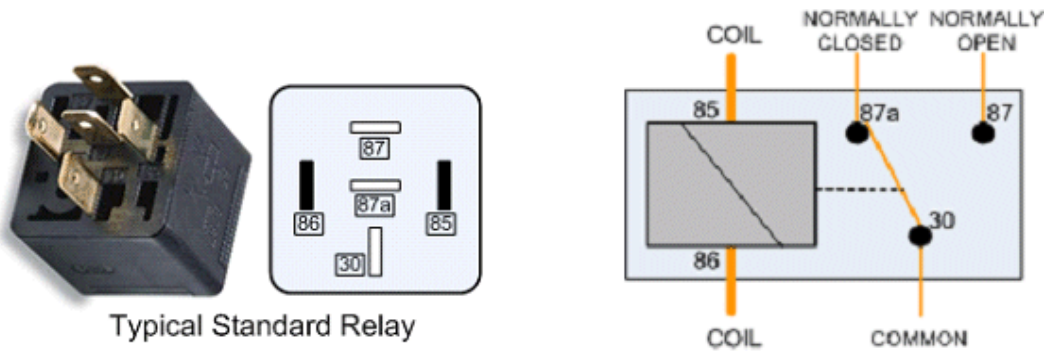

Figure 16: Relay Pin-Out

The relay figure and the pins numbers are used when describing harness outputs installations.

#### 5.1.3 LED Output

The harness LED green wire is connected to the CR unit pin no. 2. The LED itself should be connected to the LED wire and vehicle Battery. The LED provides an indication of system status. A full description of LED indications in the CR unit is presented below.

The LED output can be used as general purpose open collector output, if configured accordingly.

The LED output involves a sophisticated blinking pattern which provides monitoring status of both GPS and GSM status. The blinking pattern is constructed of repeated cycles of two blinking zones each. The first zone represents GSM functionality and the second zone, GPS functionality.

- ◆ Each zone lasts for 3 seconds with a 1-second LED off interval between them.
- ◆ A 5 second LED off interval separates each cycle.

GSM Monitoring Zone – 3 seconds	Interval – 1 second	GPS Monitoring Zone – 3 seconds	Interval – 5 seconds	GSM Monitoring Zone – 3 seconds	Interval – 1 second	GPS Monitoring Zone – 3 seconds
---------------------------------	---------------------	---------------------------------	----------------------	---------------------------------	---------------------	---------------------------------



## CR Family Hardware Installation Guide



### 5.1.3.1 GSM Monitoring Zone Definition

Status	Blinking Pattern
GSM modem off	off
Not registered to GSM / No SIM	<p style="text-align: center;">200msec</p> <p style="text-align: center;">3 seconds</p>
Registered in Home GSM network (not attached to GPRS)	<p style="text-align: center;">0.5s</p> <p style="text-align: center;">3 seconds</p>
Registered in Roaming GSM network (not attached to GPRS)	<p style="text-align: center;">0.5s</p> <p style="text-align: center;">3 seconds</p>
Attached to GPRS/home	<p style="text-align: center;">0.5s</p> <p style="text-align: center;">3 seconds</p>
Attached to GPRS/roaming	<p style="text-align: center;">0.5s</p> <p style="text-align: center;">3 seconds</p>



## CR Family Hardware Installation Guide



### 5.1.3.2 GPS Monitoring Zone Definition

Status	Blinking Pattern
GPS module off	off
GPS is unplugged / faulty	
GPS communicating, but not navigating	
GPS is in navigation mode	
GPS is in GYRO mode	

### 5.1.4 Global Output

The harness Global Output brown wire is connected to the CR Pin no. 3.

The output functionality is defined according to programming parameters (PL). In most cases, the CR unit uses this output as a global output, allowing activation/deactivation of several devices, such as blinkers, parking lights, an additional siren, etc. In this case the output shall be connected to the required device as shown in the following installation diagram.



It can be activated/deactivated by an OTA command from the control center. The following illustration provides the Global Output installation.

**NOTE:** The original wire must be cut and the relay connected between the original relay and the vehicle power.

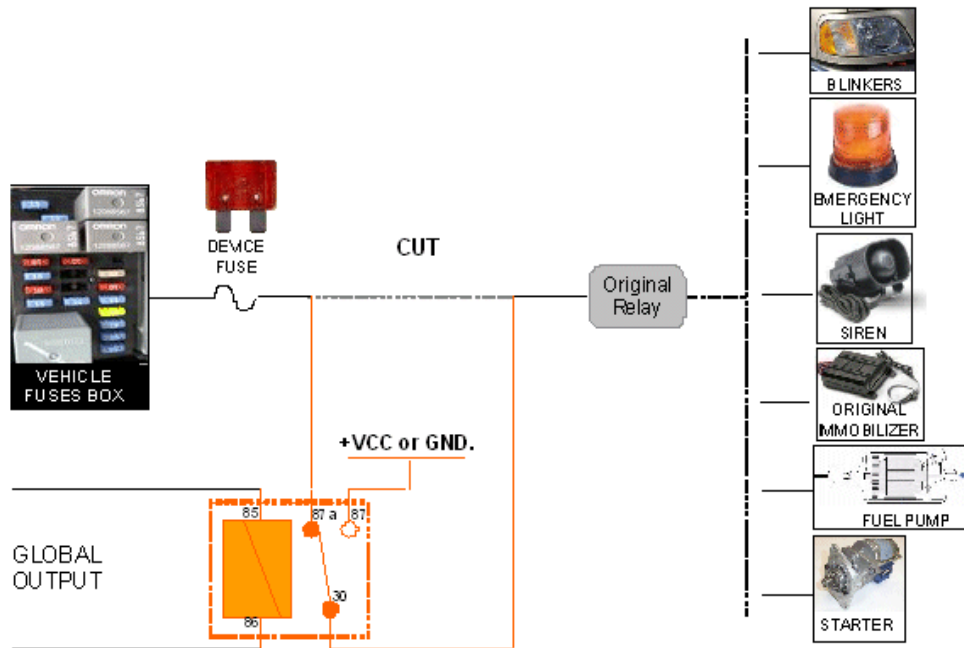

Figure 17: Global Output Installation Diagram

**NOTE:** CR300 configuration can be programmed to support Immobilizer functionality on each one of the two outputs.

## 5.2 Harness Inputs Installation Specifications

### 5.2.1 Global Purpose Input (Shock)

The harness Global Purpose Input (Shock) yellow wire is connected to the CR unit pin no. 9 and used for general purpose input.

### 5.2.2 Door Input

The harness Global Purpose Input (Door) pink wire is connected to the CR unit pin no. 5 and used for general purpose input.

### 5.2.3 Ignition Input

The harness Ignition Input Violet wire is connected to the CR unit pin no. 4 and should be connected to the ignition switch (in the ON position).



## CR Family Hardware Installation Guide



### 5.2.4 Dallas Input

The harness Dallas Input gray wire is connected to the CR unit pin no. 10 and used for Driver Identification.

## 5.3 Harness Power Installation Specifications

### 5.3.1 Main Power

The harness Main Power red wire is connected to the CR unit pin no. 1 and should be connected to the car's battery (12V / 24V) (refer to Installation Drawing, Section 5.5).

### 5.3.2 GND

The harness GND black wire is connected to the CR unit pin no. 6 and should be connected to vehicle ground (at dedicated points) (refer to Installation Drawing, Section 5.5).

#### IMPORTANT:

- The CR unit must be protected by means of a 3A fast blow fuse. The fuse should be installed either between Power Input (Pin 1) and the vehicle battery or between the GND Input (Pin 6) and the vehicle ground.
- The CR unit must be protected by means of PTC for safety certification compliance. The PTC should support Resettable Fuse 60V and  $I_{max}=40A$ . It should be installed between Power Input (Pin 1) and the vehicle battery.
- These means of protections are supported by the fuse attached to the harnesses provided by Cellocator.
- It is the installer responsibility to provide these means of protection if the fuse provided by Cellocator is not used.

## 5.4 Serial Port Connector

The harness supports a 4 pins connector allowing external devices communication to the CR unit via its serial interface (CR pins 7 and 8). The connector is illustrated in Figure 18.



Figure 18: Serial Port Connector – Front View

The serial port adaptor connector pin out is:

- ◆ Pin 2: TX



## CR Family Hardware Installation Guide



- ◆ Pin 3: RX

---

### **IMPORTANT:**

The CR serial interface supports TTL level.

You may connect it to PC USB port for programming utilizing the 711-00251 USB Communication adapter.

It is the installer's responsibility to utilize appropriate converter if RS232 levels are required.

---

## 5.5 CR Unit Installation Diagram

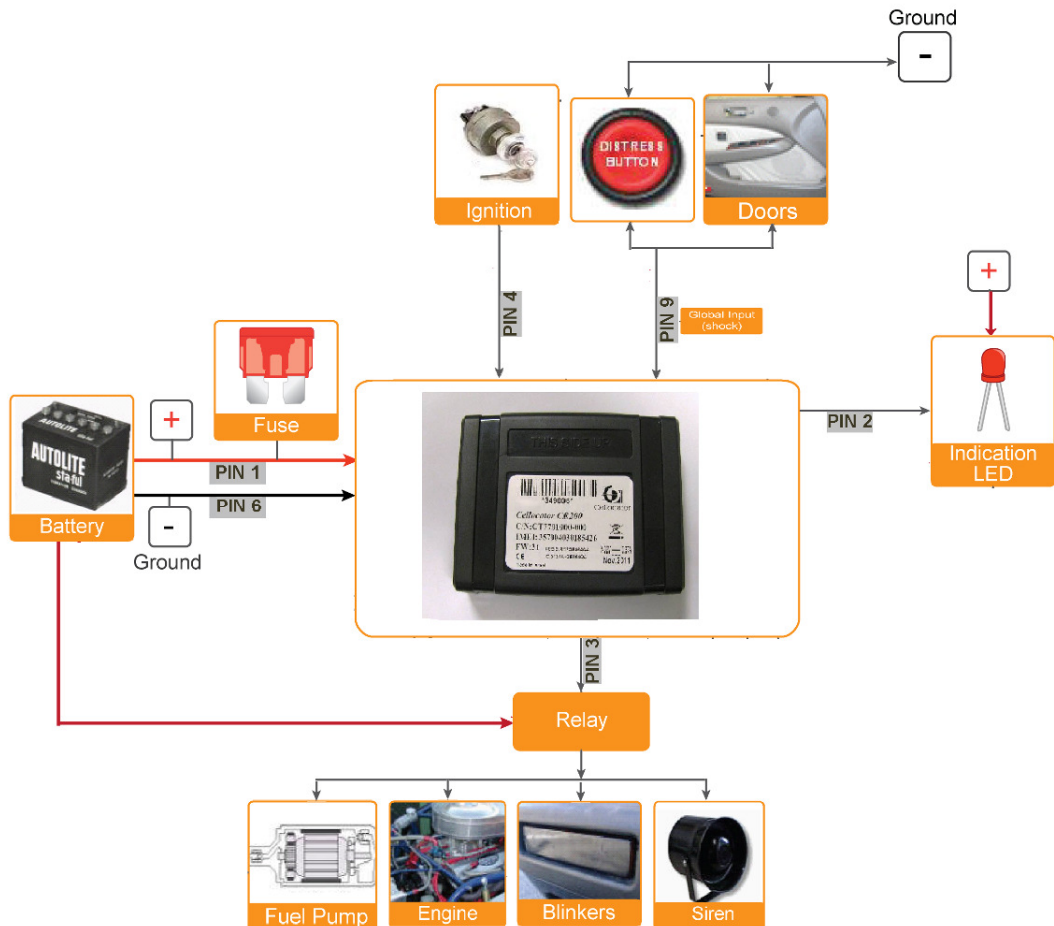

Figure 19: CR Unit Installation Diagram



## CR Family Hardware Installation Guide



### 6 Post-Installation

When you have finished installing and testing the device you have to record the relevant details. These details will help you or your colleagues to maintain the device in the future.

The best way to do this is to register all the details in an easily accessible application with a database. This application should be accessible by a PC at the installation location or even via smartphone. A less efficient solution is an Excel file or even handwritten records.

The details that should be recorded are:

- ◆ Name of the customer
- ◆ ID of the vehicle
- ◆ Type of the device installed
- ◆ Accessories installed (sensors, harness etc.)
- ◆ Cables/Harnesses used
- ◆ Location of the device in the vehicle
- ◆ Direction and inclination of the device
- ◆ Name of the installer
- ◆ Location where the installation took place
- ◆ Date of installation
- ◆ Results of installation test/issues found
- ◆ Results of communication test to the server/issues found
- ◆ Picture(s) of the installed device, harness and accessories, as installed
- ◆ Other comments